

NASA SP-56

# CONCEPTS FOR DETECTION OF EXTRATERRESTRIAL LIFE

Edited by  
Dr. Freeman H. Quimby  
Office of  
Space Science  
and Applications



*Scientific and Technical Information Division*  
NATIONAL AERONAUTICS AND SPACE ADMINISTRATION 1964  
*Washington, D.C.*

## Acknowledgments

The editor wishes to express his appreciation for special technical and editorial assistance to: Dr. Klaus Biemann, Massachusetts Institute of Technology; Dr. Ira Blei, Melpar, Incorporated; Dr. Carl Bruch, National Aeronautics and Space Administration; George Hobby, Jet Propulsion Laboratory; Dr. Norman H. Horowitz, California Institute of Technology; Dr. Thomas Jukes, University of California; Dr. Elliott Levinthal, Stanford University Medical Center; Dr. Sol Nelson, Melpar, Incorporated; Dr. Carl Sagan, Smithsonian Astrophysical Observatory and Harvard College Observatory; Dr. Gerald Soffen, Jet Propulsion Laboratory; Dr. Wolf Vishniac, University of Rochester; and Dr. Robert Kay, Philco Research Laboratories.

The entire text has been reviewed by Drs. Horowitz and Sagan.

F.H.Q.



Photograph of Mars obtained on August 24, 1956 (18 days before the opposition on September 11, 1956) by R. B. Leighton of the California Institute of Technology. The distance between Earth and Mars at the time the photograph was taken was about 35,000,000 miles. The Mt. Wilson 60-inch reflector was used with its aperture cut to 21 inches by an off-axis diaphragm. The exposure time, on Kodachrome Type A film, was 20 seconds. The positive, used in making the print, was composed by George Emmerson at the Jet Propulsion Laboratory.

This color photograph suggests that the darker areas of Mars are not necessarily "green" in color as they are often described, but may be a darker shade of the prevailing yellow-orange light areas. It is noted that the photograph as it appears here has been subjected to duplication in the course of which some minor color changes occurred. The brilliant white south polar cap is clearly evident. Rather surprisingly, this cap is probably just what it looks like—a thin layer of frozen water, perhaps in the form of hoarfrost. As the polar cap recedes, the dark areas (especially those in the same hemisphere) become darker. The dark area near the lower right-hand limb of Mars is Syrtis Major, one of the most prominent and well-known features of the planet. This feature, among others of its kind, has been of increasing interest to exobiologists in recent years. The extremely light-colored area to the right and just below the ice cap is Hellas, one of the most prominent Martian desert areas.

## Preface

The principal objective of the search for life on another celestial body is to determine the state of chemical evolution if life has not yet arisen, or the state of biological evolution if life is present. A study of such life might contribute to a universal concept of the origin and nature of living systems. In addition, chemical and microscopic examination of any fossils from a pre-existing biota could provide equally valuable information.

This subject has provoked excessive speculation by some scientists, while others seem unaware of the implications of seriously confronting it. The quest for life in space rests on a reasonable degree of geological plausibility. A widely accepted theory argues that the known planets condensed under conditions compatible with the retention of water, ammonia and methane as gases in the primitive atmospheres. Laboratory experiments have demonstrated that primeval energy sources would have synthesized numerous biologically-significant molecules from these gases. Life developed on Earth when these gases and energies were also available to the other planets. Furthermore, it is both factual and perplexing that (except for helium) there is a closer resemblance between the elemental composition of living systems and the universe than there is between that of living systems and the rocky material in the terrestrial crust on and in which such systems are in intimate residence. Indeed, living matter on Earth displays a "unity of biochemistry" which may well be a principle with cosmic as well as terrestrial validity.

These arguments do not prove the hypothesis, but suggest that we cannot avoid the experiment. It is the purpose of this publication to describe briefly this experiment for the academic community and the public. Some of the methods which have been considered thus far for the detection of extra-terrestrial life and life-related substances in the near reaches of space are presented.

HOMER E. NEWELL,  
*Associate Administrator for  
Space Science and Applications*

# Contents

CHAPTER	PAGE
Introduction . . . . .	1
I. Evidence Relevant to Life on Mars . . . . .	7
II. Mars Surface High-Resolution Near-Scan TV . . . . .	11
III. The Vidicon Microscopes . . . . .	13
IV. The Gas Chromatograph . . . . .	17
V. The Mass Spectrometer . . . . .	21
VI. The Ultraviolet Spectrophotometer . . . . .	23
VII. The J-Band Life Detector . . . . .	27
VIII. Optical Rotation . . . . .	31
IX. The Radioisotope Biochemical Probe: Gulliver . . . . .	35
X. The Wolf Trap . . . . .	39
XI. The Multivator Life-Detection System . . . . .	45
XII. The Mars Mariners and Voyagers . . . . .	49
Bibliography . . . . .	51
Suggested Reading . . . . .	53

## Introduction

The mystery of his own origin has intrigued man since earliest antiquity. Throughout the ages he has puzzled and theorized over the question of how he began, where and when.

But man is like a detective arriving at the scene some millions or billions of years after the event and trying to reconstruct the event. The principals have long since departed; most of the clues have disappeared; even the scene itself has changed.

Of equal fascination today is the question of life on other worlds—extra-terrestrial life. Do the seasonal changes in the darkening on the Martian surface mean that plant life blooms, withers, and dies there? Are there living things beneath the covering clouds of Venus despite the great heat this planet is subjected to? Did life on the Moon go underground eons back when the atmosphere departed; and does life, or its residue, still exist there? Is Jupiter actually ice encrusted beneath its hydrogen shroud; and if it is, does this preclude some form of life undreamed of by man?

Now, for the first time, man is beginning to grasp the key which may solve the question of whether or not life in some form exists on the other celestial bodies of our solar system. The key is, of course, the technology of space exploration. The search for life in space now being planned by the National Aeronautics and Space Administration is part of that technology.

The question of extraterrestrial life and the question of the origin of life are interwoven. Discovery of the first may very well unlock the riddle of the second.

The oldest form of fossil known today is that of a microscopic plant similar in form to common algae found in ponds and lakes. Scientists know that organisms like it flourished in the ancient seas over 2 billion years ago. (See fig. 1.) However, since algae are a relatively complex form of life, it is obvious

that life in some simpler form originated much earlier. Organic material similar to that found in modern organisms can be detected in these ancient deposits as well as in much older Precambrian rocks.

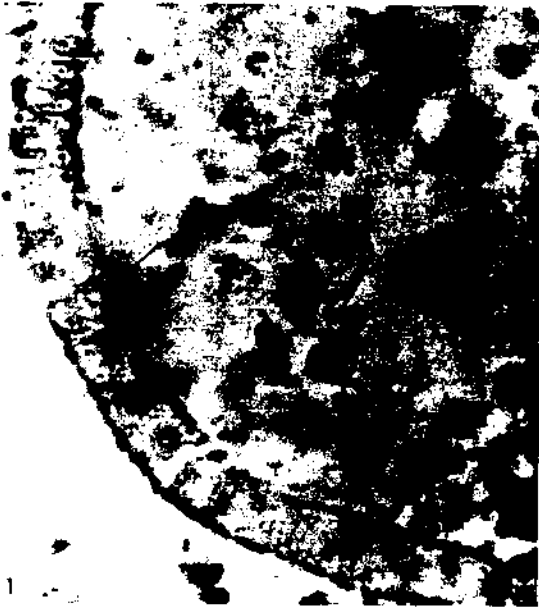

X1500



X1000

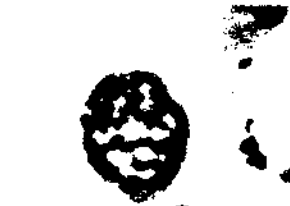

X3600



X1800

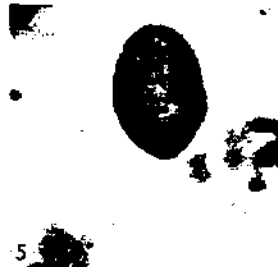

X3600



X1150

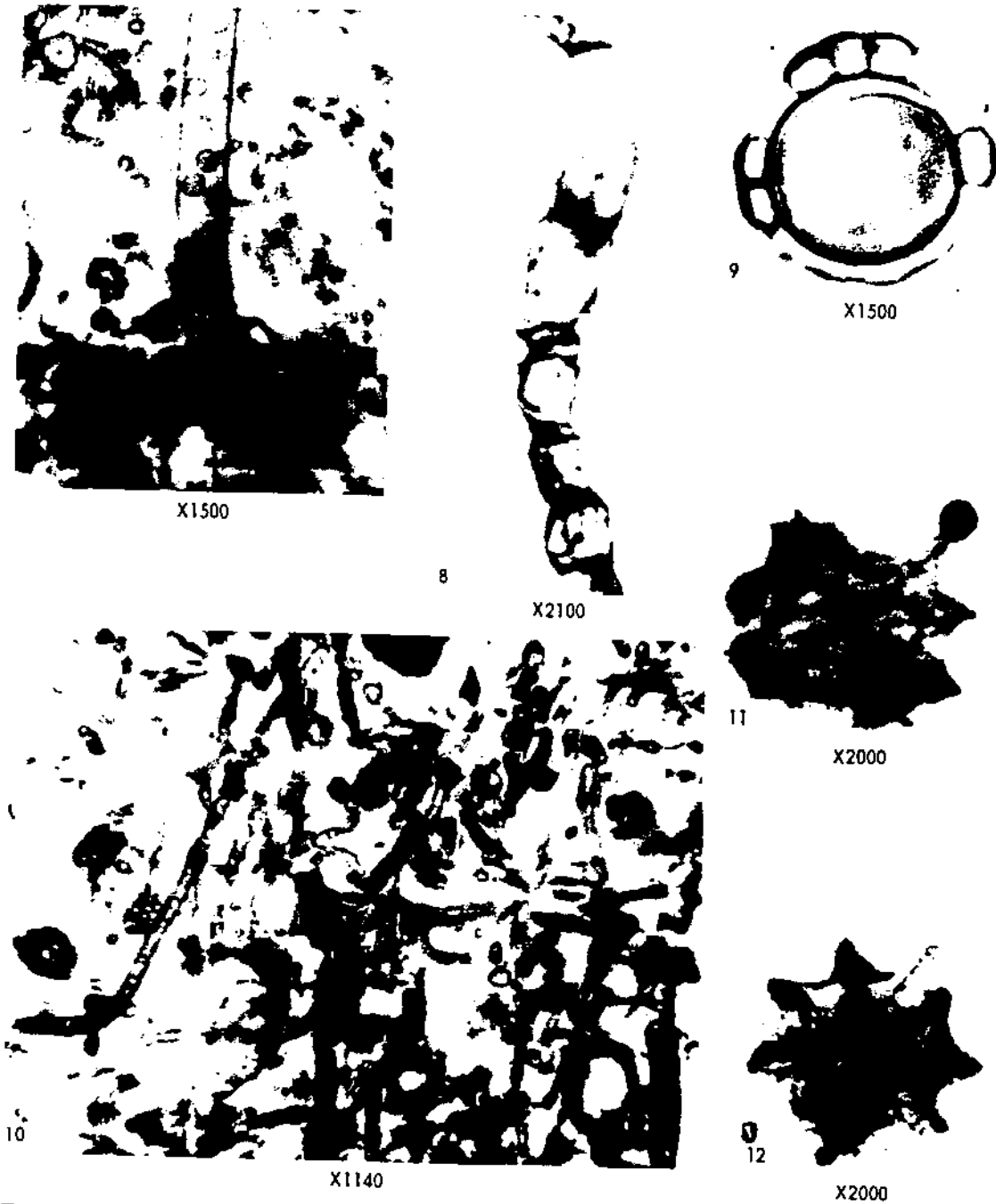

FIGURE 1.—Representative microfossils, three-dimensionally preserved in chert from the Gunfint iron-formation of the north shore of Lake Superior. This formation is of middle Precambrian age and has been dated by  $K^{40}$ - $Ar^{40}$  as approximately  $2 \times 10^9$  years. All figures are from thin sections of the chert photographed in transmitted light. Published here for the first time (from Dr. E. S. Barghoorn).



By studying the radioactive decay of minerals, scientists have determined that the surface of the Earth hardened into something like its present form about 4.5 to 5 billion years ago. Life itself probably arose during the first billion years of the Earth's history.

Although the planets now have differing atmospheres, it is believed that in their early stages the atmospheres of all the planets may have been essentially the same.

The most widely held theory of the origin of the solar system states that the planets were formed from vast clouds of material containing the elements in their "cosmic" distribution. Among the most abundant elements in our galaxy are hydrogen, oxygen, nitrogen, and carbon. These were present in the primitive atmosphere of the early Earth in the form of water, ammonia, methane, and hydrogen. Later, this reducing primitive atmosphere was altered to our present oxidizing atmosphere by the escape of hydrogen and by the formation of oxygen through the photodissociation of water vapor in the upper atmosphere and through plant photosynthesis. The Earth's present atmosphere consists of nitrogen and oxygen in addition to relatively small amounts of other gases; most of the oxygen is of biological origin. Some of the atmospheric gases, in spite of their low amounts, are crucial for life. The ultraviolet absorbing ozone in the upper atmosphere and carbon dioxide are examples of such gases.

On other celestial bodies different things happened to the atmospheres. The Moon with feeble gravitational attraction was unable to retain any atmosphere at all. Jupiter and Saturn, large in size and with a much more powerful gravitation and cooler atmospheres, retain hydrogen, hydrogen compounds, and helium.

Scientists believe that the synthesis of organic compounds preceding the origin of life on Earth occurred before its atmosphere was transformed from hydrogen and hydrides to oxygen and nitrogen, supporting their theory by laboratory experiments. In these experiments, a mixture of gases similar to the primitive atmosphere is prepared and energy is applied; i.e., energy in the form of an electric spark or ultraviolet light. These and other forms of energy were available on the primitive Earth.

By this action, simple organic molecules are formed. This is not to say that the molecules are alive, although they are constituents of living things on Earth.

Among these molecules are the building blocks of proteins (amino acids) and the building blocks of DNA. The latter is the genetic material which contains information for the development of the individual organism and which is passed from generation to generation.

Scientists, in fact, can duplicate many of the individual steps through which they think life first arose. But they cannot (or cannot yet) reconstruct the actual process by which life originated, a process which may have occupied Nature for hundreds of millions of years.

At some point energy and chemical materials combined under the right conditions and life began. Nucleic acid molecules were probably formed as well as other complex molecules which enabled the nucleic acids to replicate. Due to errors in replication, or mutations, evolution occurred, and in time many different life forms arose. Since this happened on Earth, it is possible that it also happened on other planets.

The NASA program of space exploration for the next few decades holds great promise of solving one, and of throwing light on the other, of these great twin mysteries—extraterrestrial life and the origin of life. American space technology is now developing the capability of exploring the Moon and the planets of our solar system to search there for organic matter and living organisms.

Spacecraft have flown past, and crashed on, the Moon. Mariner II, launched from Cape Kennedy on August 27, 1962, flew past Venus on December 14, 1962, taking readings and transmitting data which are significant in the search for extraterrestrial life. Mariner's measurements showed temperatures on the surface of Venus in the order of 800° F, too hot for life as known on Earth.

Other flights past Venus and to Mars are planned. Later, instruments will be sent to Mars in search of extraterrestrial life or biologically significant molecules. Culture media, microscopes, and chemical detecting devices will search out micro-organisms and life-related substances. Eventually, television cameras will look for foliage—and, who knows, footprints?

## Evidence Relevant to Life on Mars

BY DR. CARL SAGAN

The difficulty of directly detecting Martian life can be easily understood if you imagine yourself on Mars, peering through a large telescope at Earth. Detecting life on Earth—particularly intelligent life—from such a vantage point would be extremely difficult. In view of this, it is not surprising that the question of life on Mars is as yet unresolved. In general, there are three approaches which can be taken to this problem.

### **The Origin of Life**

In the past decade, considerable advances have been made in our knowledge of the probable processes leading to the origin of life on Earth. A succession of laboratory experiments has shown that essentially all the organic building blocks of contemporary terrestrial organisms can be synthesized by supplying energy to a mixture of the hydrogen-rich gases of the primitive terrestrial atmosphere. It now seems likely that the laboratory synthesis of a self-replicating molecular system is only a short time away from realization. The syntheses of similar systems in the primitive terrestrial oceans must have occurred—collections of molecules which were so constructed that, by the laws of physics and chemistry, they forced the production of identical copies of themselves out of the building blocks in the surrounding medium. Such a system satisfies many of the criteria for Darwinian natural selection, and the long evolutionary path from molecule to advanced organism can then be understood. Since nothing except very general primitive atmospheric conditions and energy sources are required for such syntheses, it is possible that similar events occurred in the early history of Mars and that life may have come into being on that planet several billions of years ago. Its subsequent evolution,

in response to the changing Martian environment, would have produced organisms quite different from those which now inhabit Earth.

### Simulation Experiments

Experiments have been performed in which terrestrial micro-organisms have been introduced into simulated Martian environments, with atmospheres composed of nitrogen and carbon dioxide, no oxygen, very little water, a daily temperature variation from  $+20^{\circ}$  to  $-60^{\circ}$  C, and high ultraviolet fluxes.

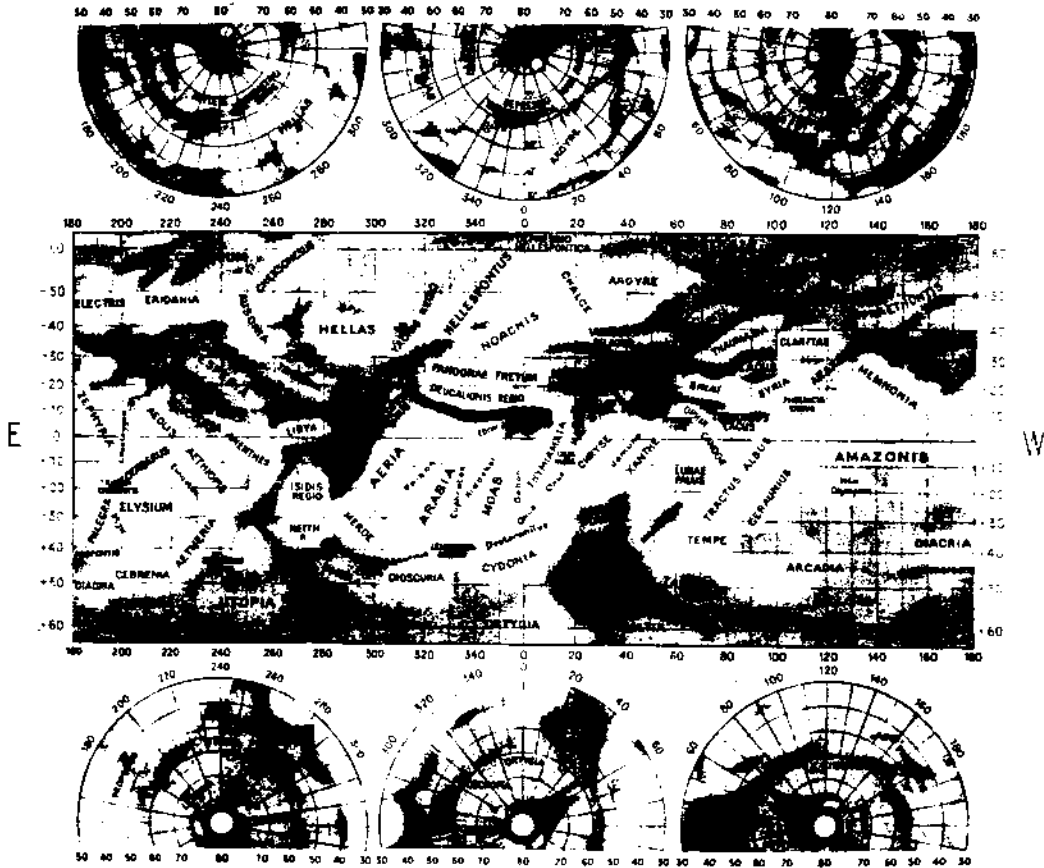

FIGURE 2.—International Astronomical Union map of Mars. In the astronomical convention, south is toward the top. The extent of the polar ice caps in summer can be seen at the top and bottom of the picture. The area Syrtis Major, at  $+10^{\circ}$  latitude,  $290^{\circ}$  longitude, is a site of strong seasonal darkness and polarization changes, and is a suspected site of hydrocarbons and aldehydes. The dark area, Solis Lacus, at  $-30^{\circ}$  latitude,  $90^{\circ}$  longitude, is a site of strong secular changes which occur erratically and cover areas up to 1000 kilometers in extent. These two sites are among those of greatest interest for early exploration of Mars.

It was found that in every sample of terrestrial soil used there were a few varieties of micro-organisms which easily survived on "Mars." When the local abundance of water was increased, terrestrial micro-organisms were able to grow. Indigenous Martian organisms may be even more efficient in coping with the apparent rigors of their environment. These findings underscore the necessity for sterilizing Mars entry vehicles so as not to perform accidental biological contamination of that planet and obscure the subsequent search for extraterrestrial life.

### Direct Searches for Life on Mars

The early evidence for life on Mars—namely, reports of vivid green coloration and the so-called "canals"—are now known to be largely illusory. There are three major areas of contemporary investigation: visual, polarimetric, and spectrographic.

As the Martian polar ice cap recedes each spring, a wave of darkening propagates through the Martian dark areas, sharpening their outlines and increasing their contrast with the surrounding deserts (fig. 2). These changes occur during periods of relatively high humidity and relatively high daytime temperatures. A related dark collar, not due to simple dampening of the soil, follows the edge of the polar cap in its regression. Occasional nonseasonal changes in the form of the Martian dark regions have been observed and sometimes cover vast areas of surface.

Observations of the polarization of sunlight reflected from the Martian dark areas indicate that the small particles covering the dark areas change their size distribution in the spring, while the particles covering the bright areas do not show any analogous changes.

Finally, infrared spectroscopic observations of the Martian dark areas show three spectral features which, to date, seem to be interpretable only in terms of organic matter, the particular molecules giving rise to the absorptions being hydrocarbons and aldehydes.

Taken together, these observations suggest, but do not conclusively prove, that the Martian dark areas are covered with small organisms composed of familiar types of organic matter, which change their size and darkness in response to the moisture and heat of the Martian spring. We have no evidence either for or against the existence of more advanced life forms. There is much more information which can be garnered from the ground, balloons, Earth satellites, Mars flybys, and Mars orbiters, but the critical tests for life on Mars can only be made from landing vehicles equipped with experimental packages such as those discussed on the following pages.

## Mars Surface High-Resolution Near-Scan TV

The first thing man generally does in a new and strange environment is to look around. This is exactly what scientists want eventually to do through one of the Voyager-class landing capsules on Mars by using photographs relayed from television cameras. This "eyes on Mars" experiment would offer genuine scientific merit for the following reasons.

1. We want to know the topography immediately surrounding the capsule. There may be both geological and biological surprises in the landscape revealed by a televised survey.

2. We would like to monitor the instrument operations.

3. Scientists and laymen alike could participate in this experiment. All could see what the scenery of the red planet is like.

TV cameras such as those used on Surveyor or Ranger (spacecraft used in lunar missions) might be adapted for use in the exploration of Mars. The Surveyor cameras use zoom lenses having a focal length range of from 25 mm (wide-angle) to 100 mm (narrow-angle). In the narrow-angle mode these cameras can produce a resolution of 0.25 milliradian per TV line. This means that at a distance of 4 meters the resolution is approximately 1 mm per TV line. These cameras are fitted with filters for color separation and polarization studies. Figure 3 shows one of the Surveyor cameras. The vidicon image tube is mounted vertically and looks up into a mirror which can be rotated in elevation and azimuth to provide viewing in virtually all directions.

The Ranger TV cameras, now well described in other reports, are also of the wide- and narrow-angle type. Although possessing a fixed focus, they can photograph in the range of approximately 1,120 miles to about  $\frac{1}{8}$  mile. Lens apertures vary and are set so that pictures can be taken corresponding to average lighting conditions on Earth from noon to dusk. The vidicon tube for each camera works on a photoconductive principle similar to tubes in commercial television cameras. The light and dark areas of the image on the

face plate are scanned by a beam of electrons which differentiate these light and dark areas by their electrical resistance. The scan lines are converted into electrical signals, highly amplified, converted to a frequency-modulated signal, sent to a 60-watt transmitter, and received on Earth. Direct mounting and use of this system on a capsule on the surface of Mars is not now possible. Nevertheless, the Ranger VII photographs of the Moon underscore the potential of the system as soon as technology permits its application to the planets.

A more sophisticated use of television cameras is illustrated by the microscope-television combination described in the next chapter.

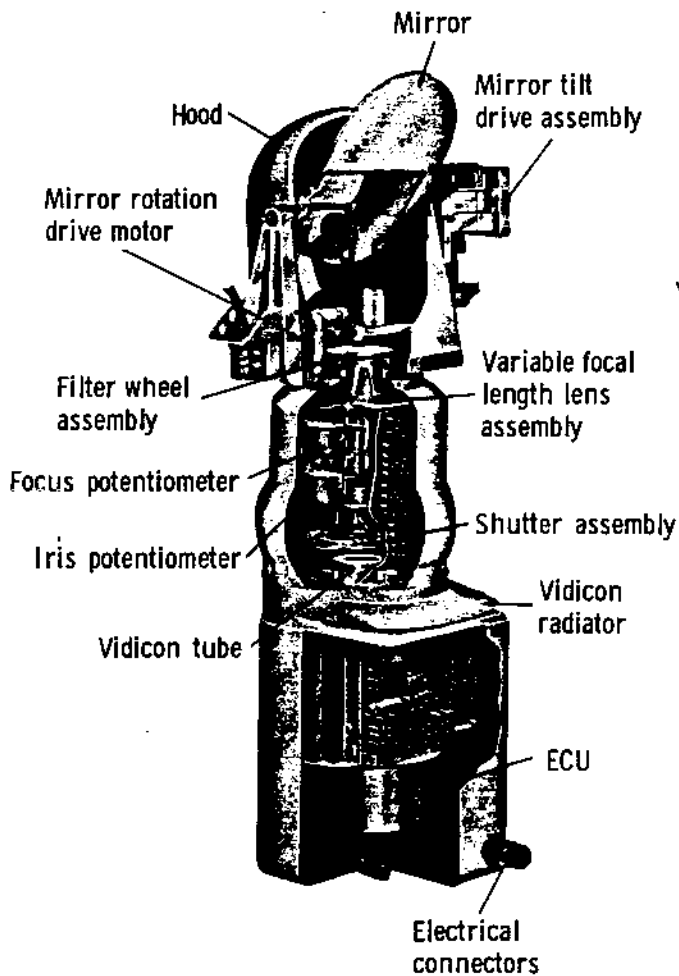

FIGURE 3.—Television survey camera.

## The Vidicon Microscopes

The detection of life by looking for it sounds elementary; however, this seemingly simple technique is extremely complex and involves numerous technical problems. The usefulness of a visual method lies in the extensive background of classical terrestrial biological observation from the macrocosm to the microcosm. In addition, the morphological approach does not depend upon assumptions concerning the nature of extraterrestrial biochemistry. Certain structural attributes, with varied degree of elaboration and application, are not expressions of particular specific form, but of life itself.

A television (vidicon) microscope for planetary exploration has been suggested by Dr. Joshua Lederberg of Stanford University. The investigation of this idea is being carried out in his Instrument Research Laboratory and in Dr. Gerald Soffen's laboratory at the Jet Propulsion Laboratory of the California Institute of Technology. These groups are assessing the problems of using the microscope as an instrument of life detection.

Terrestrial atmosphere and soil contain a multitude of viable or moribund microscopic organisms, Bacteria, algae, fungi, protozoans, and diatoms are commonly found. Fragments of organisms and fossil forms are also frequently among the components. Special parts of organisms, such as seeds, pollen grains and spores, comprise an important fraction because of their capability of surviving rigorous environmental conditions.

Recognition and identification of micro-organisms by microscopy is often difficult and uncertain; however, in many cases, characteristic morphology is highly indicative and sometimes conclusive. Specific form, size, symmetry, optical properties, surface features, pigmentation and intricate internal architecture are among those typical details which have made the microscope useful. In addition to conventional use, the microscope may be extended to carry out microspectrophotometry, microhistochemistry and microfluorometry, which



would provide chemical information concerning the object or materials in the field of view.

The simplest model of a microscope for space use is called the "abbreviated microscope." This is a fixed-focus, impaction, phase-contrast instrument

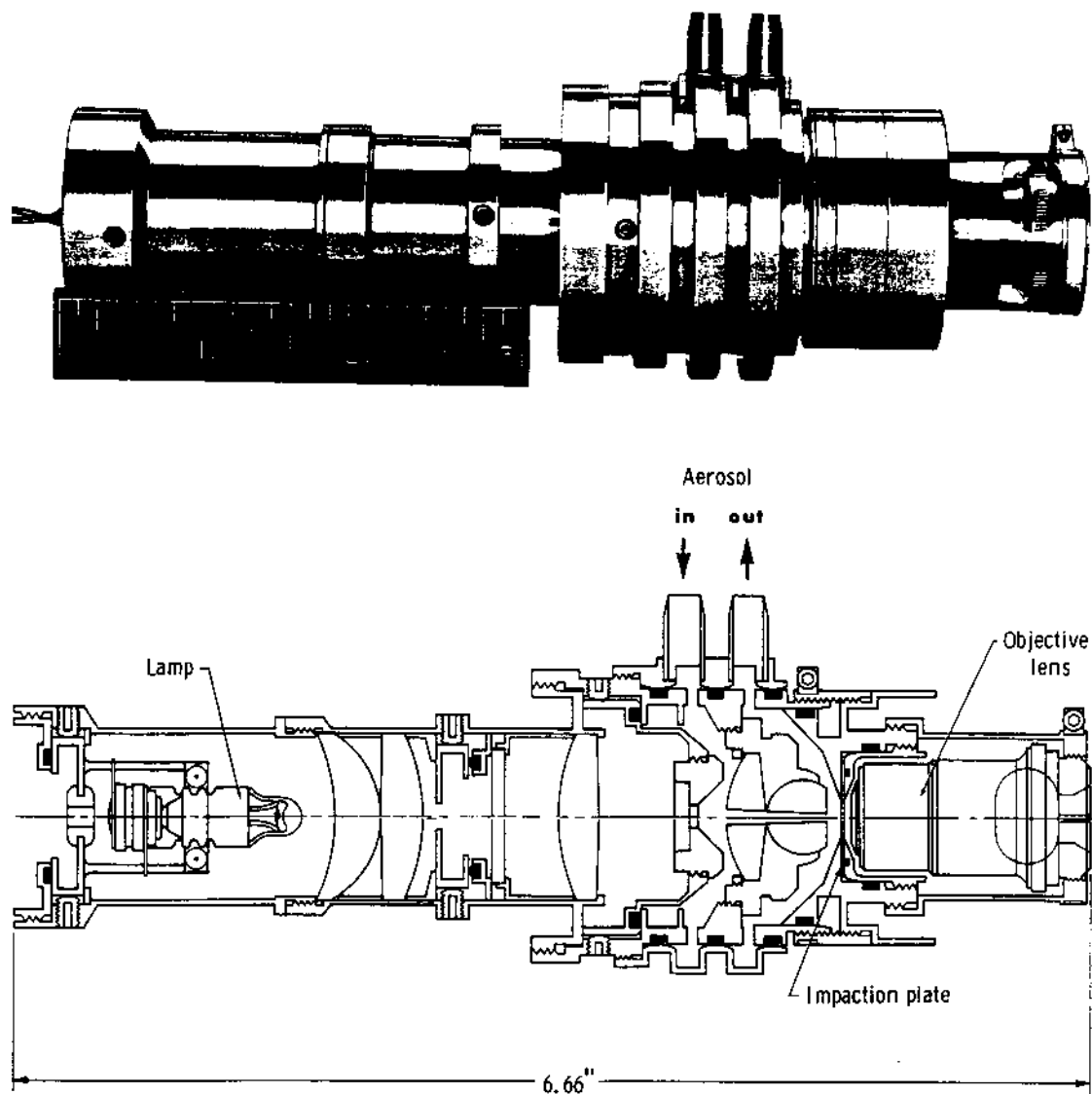

FIGURE 4.—The abbreviated microscope. An aerosol for carrying particles is injected into the instrument and is impacted onto the impaction plate through a nozzle implanted in the condenser lens. The objective lens and the lamp are fixed in relation to the plane of focus. The sample is collected through a gas-operated aerosol aspirator. The instrument has no mechanical moving parts.

which offers a unique solution to the "deposition" of a sample for optical examination (fig. 4). An aerosol sample is injected into the plane of focus of the microscope through an orifice in the condenser lens. The image is transmitted by vidicon. The lens system observes a 100- $\mu$  field with 0.5- $\mu$  resolution. The vidicon picture, when telemetered to Earth, would require a great deal of data transmission; it might take hours to send a single picture. When more power and larger antennas are available, and with special data handling techniques, this time may be reduced significantly.

A more complex idea under development employs spectral and spatial scanning as a criterion for the selection of objects of interest. Specific ultraviolet absorption of particles is carried out by scanning microspectrophotometry. This has been developed to include the fluorometric capability of detecting the primary fluorescence of native compounds and fluorescence due to products formed by specific reactants. The scanning technique is also being investigated for use with biological stains.

Other areas being explored are automatic focusing, changes in magnification, the use of more sensitive imaging devices, and improved sample preparation to remove the inorganic fraction.

## The Gas Chromatograph

Gas chromatography has been proposed as an excellent method for detecting the gases of planetary atmospheres and for identifying organic chemical compounds which are of biological interest.

The essential parts of the gas chromatograph are a long tube, or *column*, containing a powdered material which will adsorb, or bind, different gases with different degrees of strength and a detector that is placed at one end of the tube. During an analysis, the unknown sample, which usually consists of a mixture of gases, is forced through the column by an inert gas, or *carrier gas*, such as helium or argon. The gases of the sample that are more strongly bound to the material in the column pass through more slowly than the gases that are weakly bound. In this way different gases pass out of the column at different times and are indicated by the detector. (See figs. 5 and 6.)

A basic gas chromatograph for detecting and measuring atmospheric gases or for analyzing organic compounds of biological interest is shown in figure 6. In the case of an atmospheric analysis, a sample of the atmospheric mixture is transported to the *sample injector*. A constant flow of carrier gas from the carrier-gas storage tank is delivered to the column by the *flow regulator* and is permitted to flow continuously before injection of the sample. The sample is then put into the carrier-gas stream by the sample injector. The different gases in the mixture separate as they pass through the column, with each gas finally passing through the *detector*, and causing it to produce an electrical signal. The signal is fed into an electronics system where it is amplified and transmitted back to Earth.

Under suitable conditions, the strength of the signal will indicate the amount of each gas (see fig. 7). The kind of gas is determined by the length of time it takes to pass through the column. The detectors used in gas chromatography usually detect changes in the physical properties of the carrier gas; for example, electrical or thermal conductivity.

## DETECTION OF EXTRATERRESTRIAL LIFE

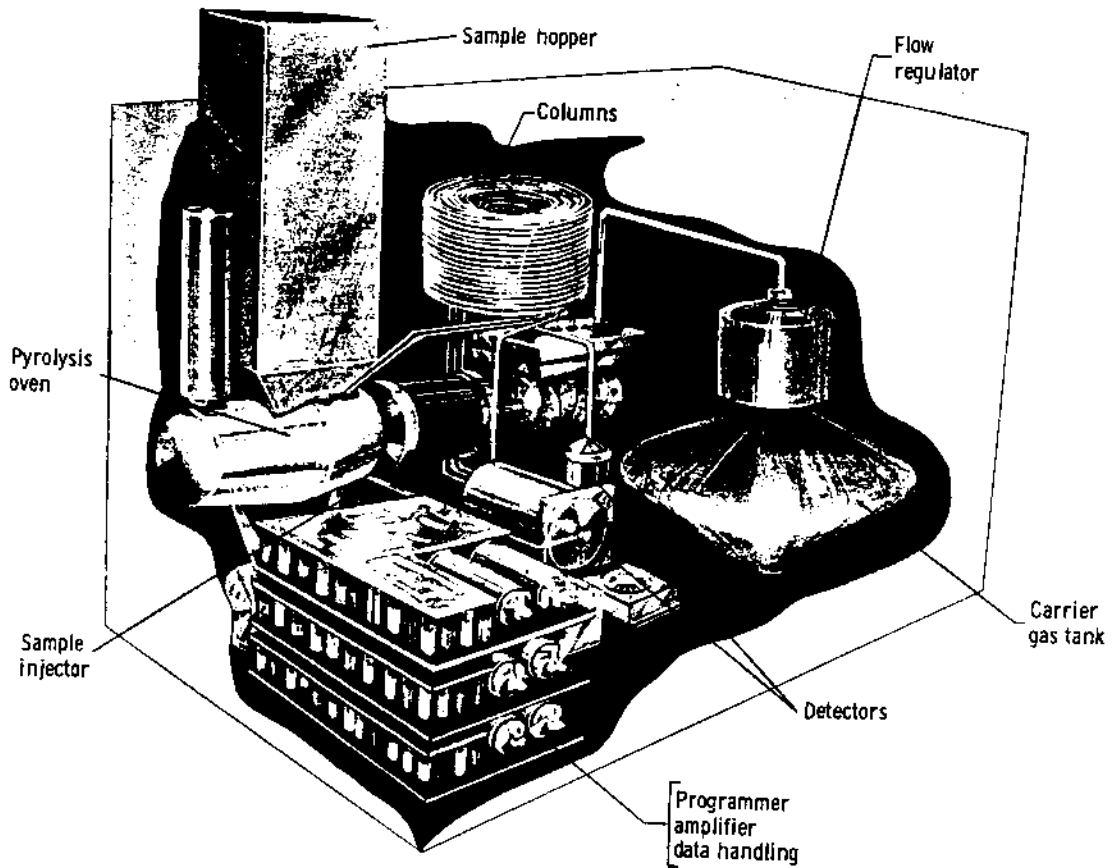

FIGURE 5.—Gas chromatograph.

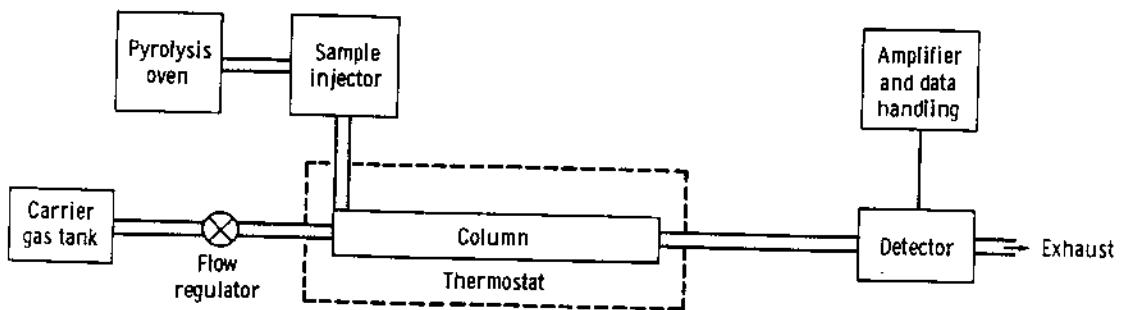

FIGURE 6.—Block diagram of the gas chromatograph.

Biological substances do not normally occur as vapors and therefore cannot be directly detected by gas chromatography. In the analysis of these compounds it is necessary to convert nongaseous materials to vapor form before

they can be analyzed by gas chromatography. This can be done in two ways. One way is to heat the sample at relatively low temperatures; for example, 100° C to 150° C. With this treatment, some biological compounds can be converted to vapors which can be injected into the carrier gas and analyzed in the usual way. Other biochemical compounds cannot be vaporized so easily and must be heated to higher temperatures. When these substances are strongly heated their molecules break up into smaller molecules, some of which are gaseous. By analyzing these smaller molecules on the gas chromatograph it is possible to tell what the original biological substances were. This type of analysis requires a great deal of research in order to learn how large molecules break down when they are heated at high temperatures. The oven in figure 6 is used to heat biochemical compounds in order to convert them to gases.

Through the use of gas chromatographs that are designed to perform an analysis automatically on space probes landed on the surface of Mars it will

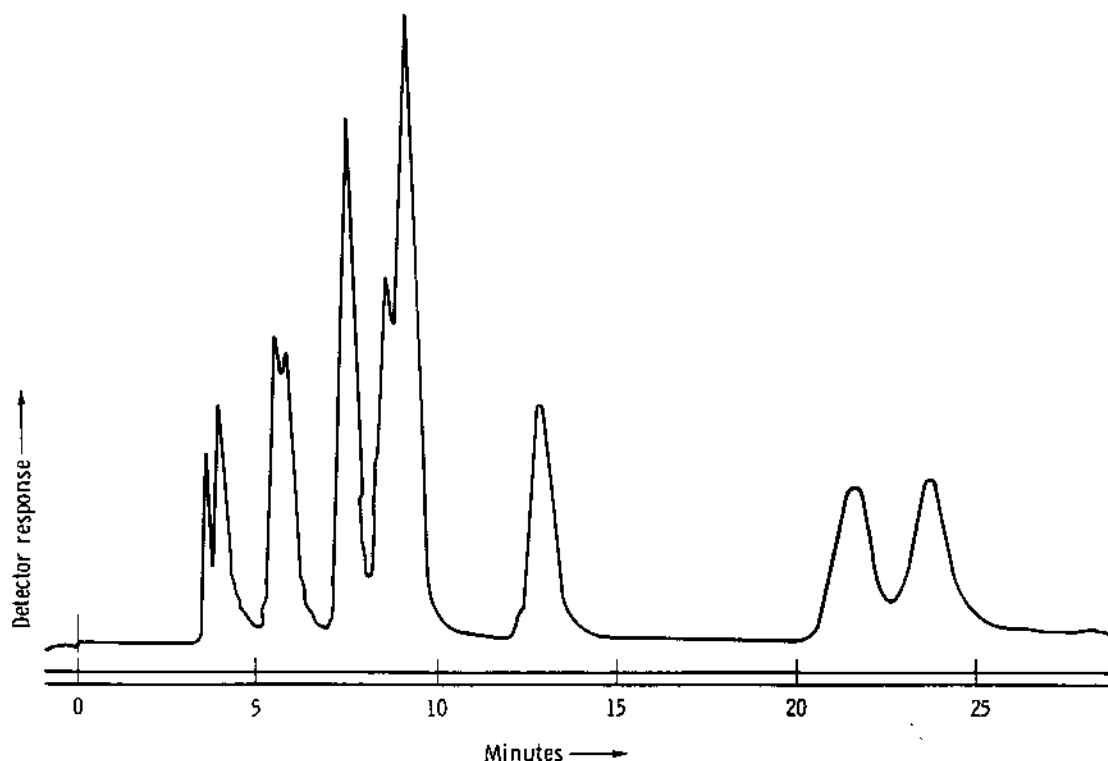

FIGURE 7.—Typical gas chromatogram. Zero is the time of injection. The time on the minutes scale, for each peak, is its *retention time*, and identifies the gas passing through the detector. The area under each peak is proportional to the amount of gas.

be possible to determine what gases in the Martian atmosphere may be important to living organisms. For example, tests for water vapor, oxygen, carbon dioxide, and nitrogen can be made as well as for many other gases, and samples of Martian soil can be collected and heated. If these samples contain organic matter, it will be possible to tell whether substances which are known to be part of living organisms are present. If proteins, nucleic acids, sugars or fatty substances are found, this would be strong evidence that life is present, although it would not be conclusive. The information obtained through gas chromatography, combined with information obtained through other experiments, would not only establish the presence of life, but it would tell whether or not this life was chemically the same as terrestrial life.

One of the outstanding advantages of the gas chromatograph is its versatility. It can be made very complex or relatively simple depending upon the kind of analysis desired and the constraints of the space probe mission. By using a system having several columns and detectors, an instrument can be designed which will analyze a wide variety of biochemical substances. This would be desirable if there is no prior clue to the possible kinds of organic chemicals in an unknown mixture, such as might be the case for a sample of Martian soil.

A second important advantage is that the analysis results in the separation of complex chemical mixtures. This feature permits confirming the analysis of each constituent by other methods; for example, mass spectroscopy.

Finally, the instrumentation is readily adaptable to miniaturization and ruggedness of construction, which is an essential feature for instruments intended to perform remote automatic analysis on unmanned space probes.

Several model instruments have been studied for application to the biological exploration of the solar system. These instruments range from 5 to 14 pounds in weight and are of various degrees of complexity. Gas chromatographs which can analyze planetary atmospheres in 10 seconds are being studied, as well as instruments which can detect tens or hundreds of gaseous compounds in a single analysis. Because of this extreme versatility, the scientists working with gas chromatography believe that it is one of the most useful methods for the detection of biologically relevant chemical compounds and the constituents of planetary atmospheres.

## The Mass Spectrometer

Although mass spectrometry, like gas chromatography, cannot prove the existence of life, it is an experimental tool which would enable us to learn much about the organic chemistry of Mars.

The mass spectrometer approach to exobiological studies is being carried out under the supervision of Dr. Klaus Biemann at the Massachusetts Institute of Technology. Dr. Biemann has concentrated much of his experimental work on amino acids and peptides. This method accomplishes identification through the mass spectra (i.e., the distribution of the masses) of the pyrolysis products of the introduced samples. In one type of instrument an amino acid is heated near the ion source. The molecular fragments so produced vaporize off the sample and are accelerated according to their masses onto an electron multiplier. The identification of the original amino acid is based on the characteristic masses of these fragments.

The mass spectrometer is perhaps unique for the specific identification of small amounts of compounds which have been roughly classified by other methods. While not as sensitive as color reactions, ultraviolet absorption and fluorometry, mass spectrometry is an extremely versatile and powerful method for identifying organic compounds. The ability to recognize organic structures, regardless of whether they do or do not show any resemblance to the molecules with which we are familiar in terrestrial biology, could be crucially important for Martian exploration.

The sample size for mass spectroscopy ranges from a few tenths to a few millionths of a milligram. Spectral interpretation is simplified if this small sample is not too complex. Therefore, some sample preparation is required, with gas chromatography being the favored method for accomplishing this.

Mass spectrometry could also provide data on the composition of the atmosphere and the abundance of ratios of stable isotopes of the elements of low atomic number. Both of these areas are of obvious relevance to the biological exploration of celestial bodies within the solar system.

## DETECTION OF EXTRATERRESTRIAL LIFE

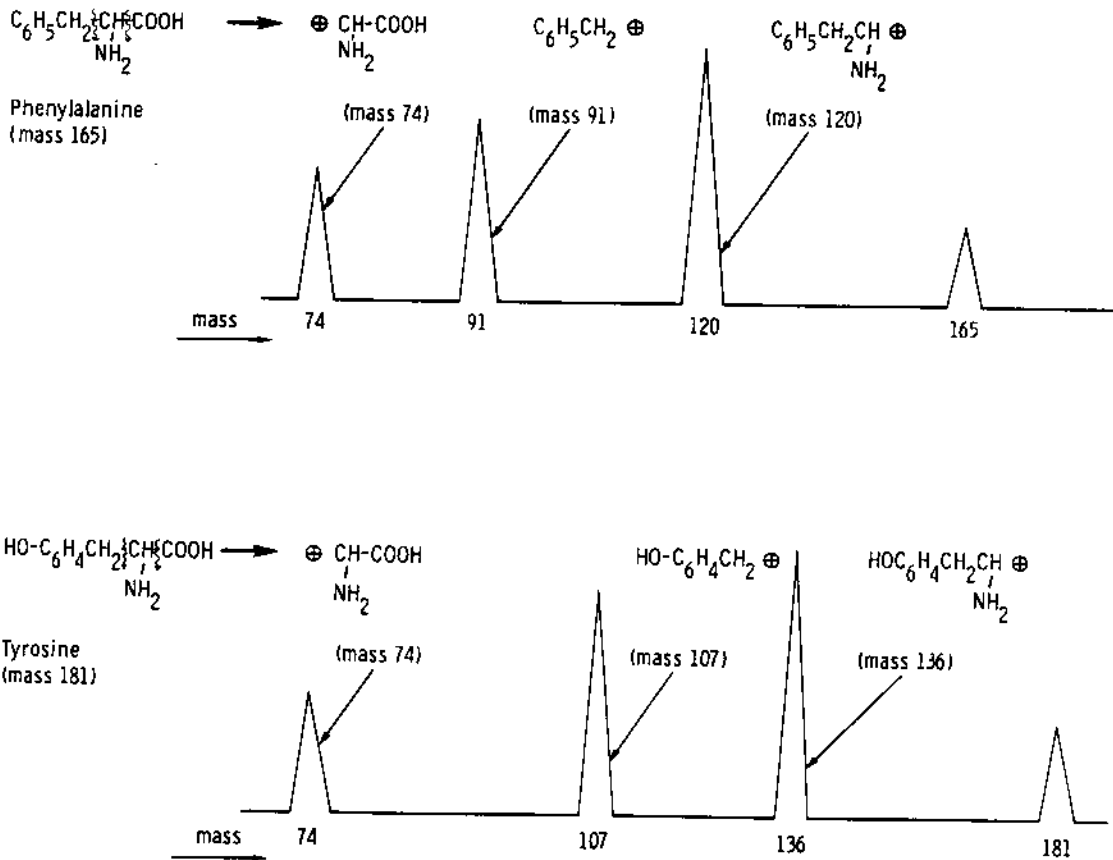

FIGURE 8.—Origin and appearance of the mass spectra of two amino acids.

Figure 8 shows the mass spectra of two amino acids, phenylalanine and tyrosine. Upon electron-bombardment, certain bonds in the molecules of phenylalanine (top) and tyrosine (bottom) are broken to form various positively-charged fragments which the mass spectrometer separates and records according to mass (see curves). Both give mass 74, characteristic of many amino acids, but the rest of the peaks differ because tyrosine contains one more oxygen atom than phenylalanine.

Any mass spectrometer built for use in space would, of course, incorporate a collection apparatus for sampling, sensors to note the results, and telemetry equipment to communicate these results back to Earth. Such information would be obtained quickly with this instrument. The entire mass spectrum of a biological molecule can be scanned in a few seconds. The instrument should be designed for the determination of spectra up to a molecular weight of 250.



## The Ultraviolet Spectrophotometer

The use of ultraviolet spectrophotometry for detecting peptide bonds is being studied to determine whether it can be applied to the search for life on other planets. This program is under the direction of Dr. Sol Nelson at Melpar. Since all proteins contain peptide bonds, and since all living things on Earth contain proteins, the detection of extraterrestrial peptide bonds might be consistent with the presence of living things.

Before going any further, it would be worthwhile to explain what ultraviolet spectrophotometry is, and what proteins and peptides are.

Suppose a child is in a swing that is moving at a rate of two swings each second. We can say that the *frequency* is 2 cycles per second. If you stand behind him and push the swing at the same frequency (2 times per second), the swing *absorbs* the energy and its amplitude increases. Your pushing frequency is said to be in *resonance* with the swinging frequency. If you try to push at a frequency of 3 cycles per second, it is obvious that the swing will not absorb the energy as efficiently.

As another example, let us consider the case of sound. Picture a room with two pianos, one with a full set of strings and one with only one string—middle C. Now, if the keys of the complete piano are struck one at a time, you will note that the single string on the incomplete piano emits a sound only when middle C (or a note of which it is an overtone) is struck on the complete piano. Here, too, the single string *absorbs* energy and begins to vibrate when it is in resonance with the energy. Thus, striking a D does not cause the C string to vibrate because their vibration frequency is different.

Although the examples deal with mechanical energy, the same phenomenon occurs with electromagnetic energy which includes X-rays, ultraviolet, visible light, infrared, radar and radio waves. Each of these terms applies to a range of electromagnetic energy. The highest frequencies are in the X-rays, and the lowest frequencies are in the radio. Now, if we recall that matter consists of

molecules, and that the molecules, their atoms and their electrons are always vibrating, then we can expect to find some of these vibrations to be in *resonance* with the vibrations of a portion of the electromagnetic spectrum.

If we want to study the absorption of ultraviolet light by substances, we need an ultraviolet spectrophotometer. This is an instrument that can separate ultraviolet light into bands of very narrow frequency ranges, and can measure the amount of ultraviolet passing through a substance. Thus, if we isolate a

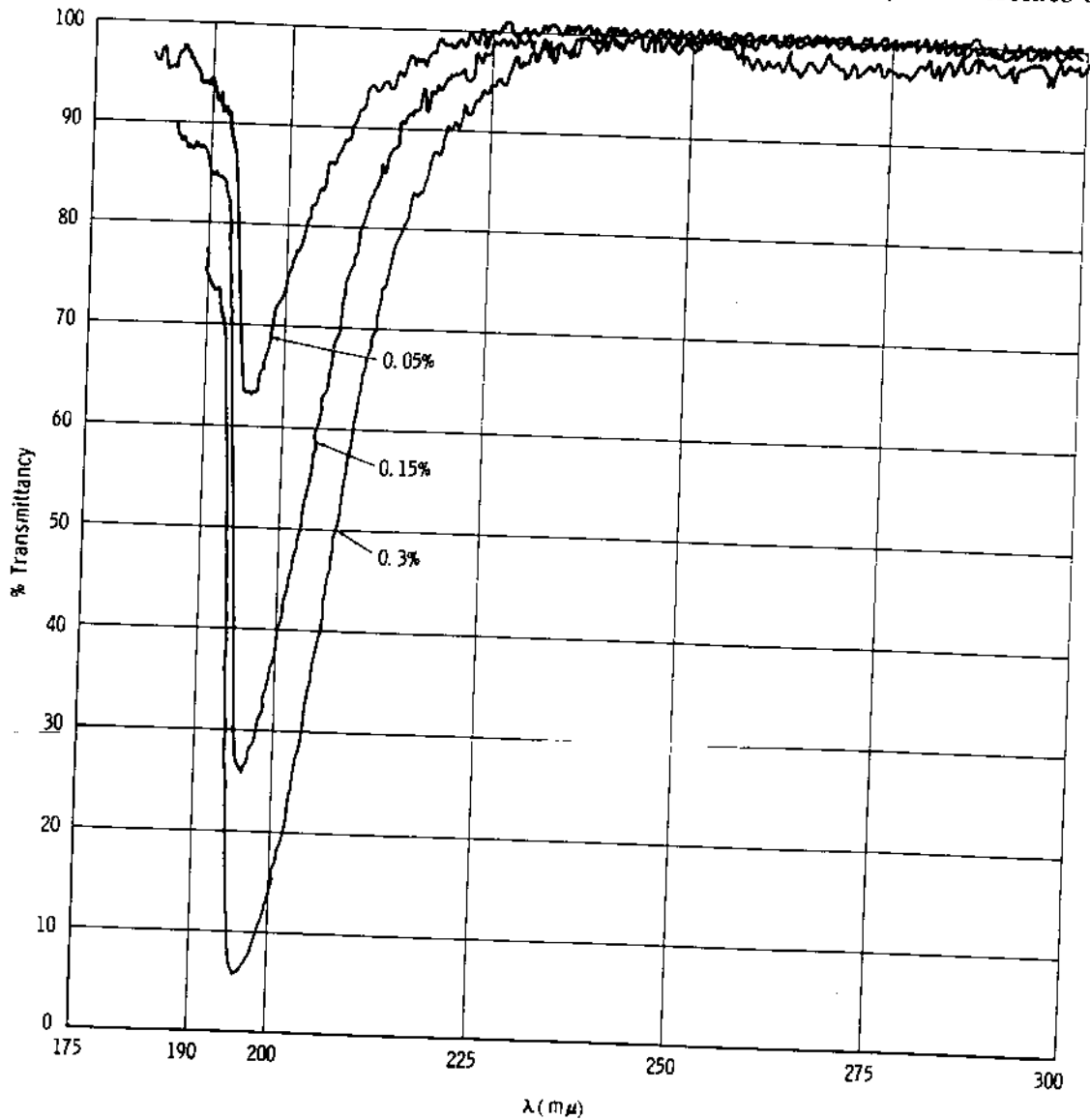

FIGURE 9.—Absorption spectra at pH 1; Alanylglycylglycine (tripeptide).

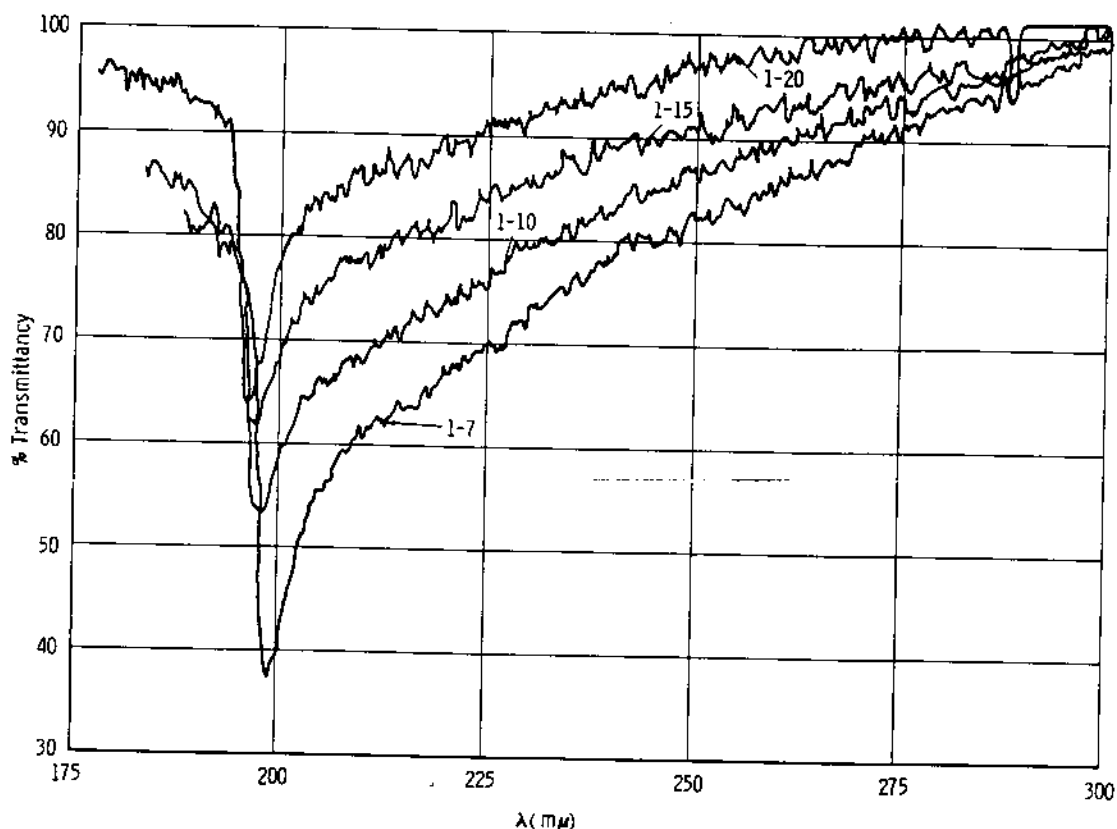

FIGURE 10.—Absorption spectra of soil extract (NaOH).

band of light and pass it through a substance and find that 100 percent of the light has passed through, we say that the ultraviolet was not absorbed. This means that the substance does not have vibrations of the same frequency as the ultraviolet. Now, if we pass a band of ultraviolet of another frequency and we find that only 10 percent of the light passes through the substance, then we know that the light was absorbed and that the substance had a vibration of the same frequency as that particular band of ultraviolet.

Proteins are large, complex molecules consisting of amino acids linked together in long chains that are folded into characteristic shapes. The amino acids are held together by *peptide bonds*, and their combination joined in such a fashion is called a *peptide*. A combination of two amino acid molecules is a dipeptide; three are a tripeptide; many are a polypeptide. A protein is a large polypeptide, or a combination of several polypeptides. When a protein is *hydrolyzed*, it is split into peptides, and these are then split into amino acids. (This is what happens in the stomach and intestine when proteins are digested.)

Now, if we study the absorption of electromagnetic energy by proteins, it is seen that a portion of the spectrum in the far ultraviolet region (around 1950 Å) is characteristically absorbed by the protein. Further study shows that the particular vibration in resonance with the ultraviolet is somewhere in the peptide bond. A tripeptide absorbs twice as much as a dipeptide. A polypeptide with 100 bonds (101 amino acids) absorbs one hundred times as much energy as a dipeptide. As a protein is hydrolyzed we see that the absorption of ultraviolet light decreases, and when it is completely hydrolyzed and all the peptide bonds are broken, there is no more absorption of this region of the ultraviolet.

Unfortunately, peptides are not the only substances that absorb in this region, and some confusion might result. A study of the absorption by other substances shows, so far, that hydrolysis does not affect it. Thus, it can be said for the present that if the substance absorbs far ultraviolet before and after hydrolysis, it is *not* a peptide, but if hydrolysis reduces the absorption, it may be a peptide.

If further research warrants it, a small, rugged spectrophotometer will be built. The instrument will be able to collect a sample of Martian soil, treat it with solvents and place a portion in each of two quartz vessels. One sample will be hydrolyzed and the other will not. Then the instrument will take spectrophotometric readings of both samples. If the readings are different, a message will be sent to scientists on Earth that peptides exist on Mars.

The ultraviolet absorption spectra of three different concentrations of alanyl-glycylglycine at pH 1 are shown in figure 9. Figure 10 illustrates the ultraviolet absorption spectra for sodium hydroxide extracts of soil (ratios are amounts of NaOH to H<sub>2</sub>O in extracting solutions).

## The J-Band Life Detector

This experiment is being studied for NASA by Dr. R. E. Kay and Dr. E. R. Walwick at the Philco Research Laboratories and is designed for use on Mars.

Because of the probable evolutionary history of the Martian environment, it is believed that Martian life will be based on similar chemical constituents and evolutionary principles as life on Earth. On Earth, life resides only in systems which are composed of molecular aggregates (macromolecules) known as proteins, nucleic acids and polysaccharides. Therefore, it is reasonable to assume that the detection on Mars of macromolecules having properties similar to proteins, nucleic acids or carbohydrates, will provide some support for the view that life exists on the planet. When certain dyes interact with macromolecules, color changes (metachromasia) occur which can serve to identify and detect biological materials. The present experiments have been concerned with the changes produced in the absorption spectrum of a dibenzothiacarbocyanine dye when it interacts with trace amounts of biological macromolecules. The spectral changes occurring when this dye reacts with biological macromolecules are unique in regard to the diversity of the changes that occur and the large amount of information which can be deduced.

In this case, the interaction of the dye with biological macromolecules always produces an increase in absorbance at new maxima. There are seven different regions of the spectrum in which absorption maximum are found. These are located at approximately 450, 480, 508, 535, 560, 575, and 650  $m\mu$ . The peak in the 650- $m\mu$  region is referred to as a J-band, being named after E. E. Jelly who described it in detail. This absorption band is particularly interesting because, of the macromolecules which have been tested, only those of biological origin interact with the dye to produce this absorption band. This is indeed fortunate, since the J-band has properties which make it especially useful in a detection scheme. It lies almost entirely outside the absorption region of the normal dye absorption spectrum, and the absorption coefficient is extremely high. Because of this, an increase in absorbance in the J-band region occurs

in the presence of very low macromolecule concentrations and variations in the reference (dye band) are negligible. Thus, the experiment has been referred to as the "J-band life-detector." This title is convenient because of its brevity, but it focuses attention on only one aspect of the method. The program is concerned not only with the J-band, but also with other alternations of the dye spectrum which result from the interaction of the dye with macromolecules.

The maxima which appear, and their exact wavelength, are functions of the macromolecule structure and the nature of its functional groups. Thus, for example, interaction of the dye with native deoxyribonucleic acid (DNA) produces a single peak at 575  $m\mu$ , whereas its interaction with denatured DNA causes a single peak at 540  $m\mu$ . On the other hand, proteins may produce multiple bands which occur in the 650-, 575- and 480- $m\mu$  regions of the spectrum. With proteins, a band can always be produced in the 650- $m\mu$  region of the spectrum; the exact wavelength of this band appears to be a function of the nature of the protein. Variables, such as change in acidity or alkalinity (pH) and temperature, cause changes in the absorption spectra of macromolecule-dye complexes which are related to the nature of the macromolecule. In general, the method is sensitive to 0.1 to 1 microgram of macromolecule per ml, and the absorbance of the associated complex is proportional to the concentration of the macromolecule.

The positions of the new absorption maxima appear to be a direct property of the spacing of the functional groups on the macromolecule, the rigidity of the macromolecule structure and the sequence of the anionic and cationic sites. The effects produced by changes in temperature and pH are apparently associated with modification in the folding and coiling of the macromolecule, the dye-macromolecule equilibrium and the ionizability of the functional side groups. Thus, by observing the spectral changes which occur when this dye interacts with a macromolecule and by appropriate manipulations of environmental variables, it is possible to detect trace amounts of macromolecules, distinguish between macromolecules which are difficult to differentiate by conventional methods and obtain information about the structure of macromolecules and estimate the macromolecule concentration.

It is expected that on Mars the experiment will be carried out in the following manner: The test capsule will acquire a soil sample, extract the macromolecules and mix them with the dye solution (sample solution and preparation). The absorbance of the dye-macromolecule mixture will then be determined.

In laboratory tests, a number of soil samples have been analyzed for macromolecules by the scheme indicated for the Mars experiment. In each case,

changes in the absorption spectrum of the dye, indicative of the presence of macromolecules, were observed. This was true for soils which had a total organic carbon content as low as 0.2 percent. Concentrated extracts from some of the soils, which exhibited new absorption peaks in the 535- and 650- $m\mu$  regions of the spectrum, were analyzed for macromolecules by conventional laboratory methods. Macromolecules were isolated and amino acids and monosaccharides were obtained when the macromolecules were hydrolyzed, indicating that the macromolecules present in the soils were proteins and polysaccharides. This is in agreement with the results obtained by the dye test and strongly indicates that the method will be very useful for the detection of macromolecular species which are characteristic of all living material as we know it.

Figure 11 shows three absorption maxima. The first, at 505  $m\mu$ , is the region of normal dye absorption. The others, at 575  $m\mu$  and 648  $m\mu$ , are absorption bands due to the interaction of the dye with a 0.002-percent solution of oxidized ribonuclease.

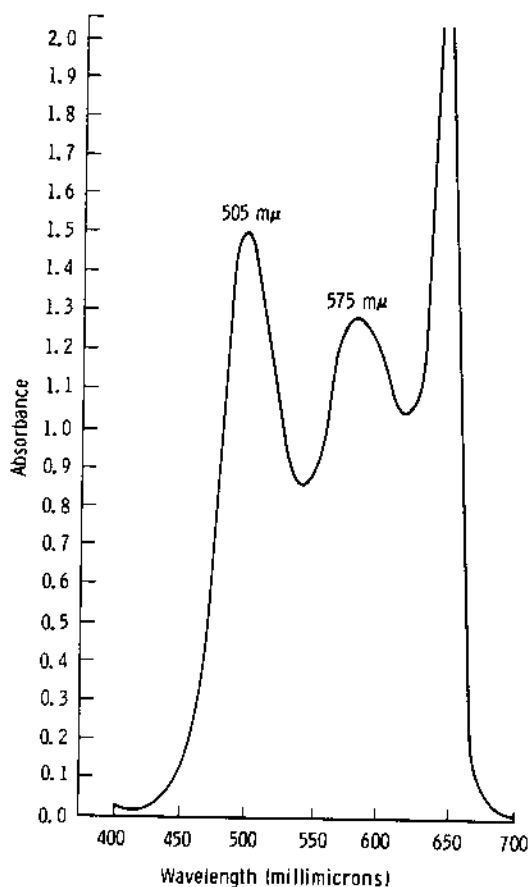

FIGURE 11.—Three absorption maxima in the J-band region.

## Optical Rotation

To determine the presence of life on other planets through remotely controlled instruments, two factors must be considered. First, we postulate that life on other planets has a chemistry similar to ours. This is an obvious first guess and may well prove to be approximately correct. As was shown in the introduction, there is reason to believe that the chemical events occurring on the primitive Earth also occurred on other planets of the solar system. Secondly, what is life and how do you know when you have found it?

"This," says Dr. Ira Blei, "brings us to the heart of the problem of the search for life on other planets." Dr. Blei, of Melpar, is the scientist in charge of the optical rotatory experiment for NASA.

How can one design single experiments which will provide enough information to permit a decision to be made concerning the existence of biologically significant molecules? Life has become very difficult to define in just a few words. The highest form of life on Earth, man, is a collection of very complex molecules having certain life-like properties associated with them. At the other end of the scale are the many types of simple chemical substances—sugars for example—which are obviously not alive. Further, somewhere between the two extremes are systems which are sometimes "alive" and sometimes not: the viruses.

So, we may look for a substance or property which is common to all life. One measurable property which has consistently been found in all living systems is optical rotation. A substance is said to possess optical activity when a "flat ribbon," or plane wave, of light (polarized) passing through this substance is twisted, or rotated, so that the flat ribbon of light emerges in a new plane.

This ability to rotate the plane of polarized light is associated with molecular structure in a unique manner, just as the absorption spectroscopic characteristics are unique. Not all materials are capable of rotating the plane of polarized



light; however, nucleic acids, proteins, and carbohydrates, all associated with life, do.

To measure the ability of a substance to rotate plane polarized light, it is necessary to place the substance between two polarizing filters. Plane polarized light passes through the substance into the second filter, which has been rotated so that no light can penetrate. Now, if the natural material can cause the plane ray to twist, some light will begin to leak through the second, or analyzer, filter. To restore the initial condition of the incident light leak, the analyzer must be rotated through a certain angle. The extent to which the analyzer is rotated is the measure of net optical rotation. Figure

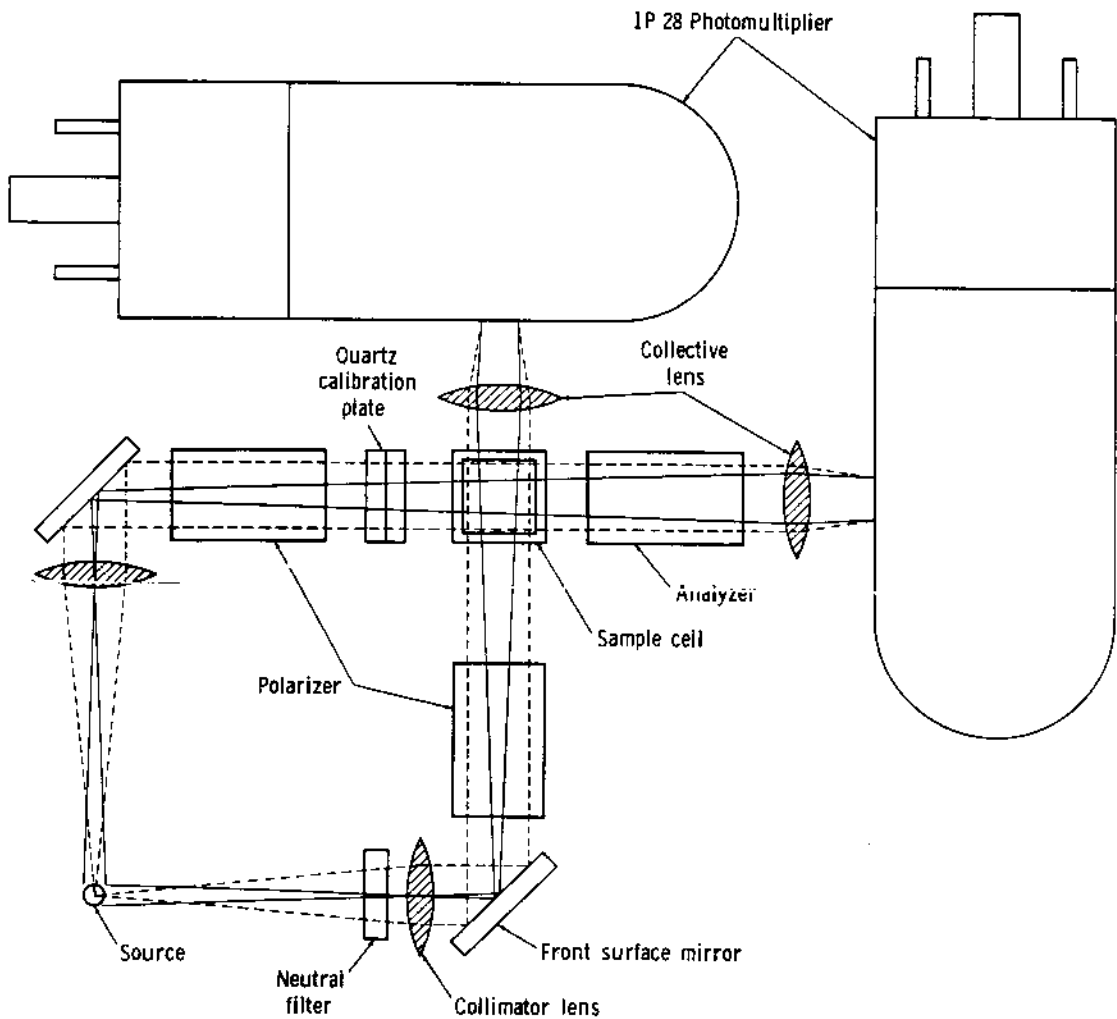

FIGURE 12.—Optical system for optical-rotatory device.

12 shows the general layout of the optical component of the optical rotation device.

An important feature of optical rotation is that it is thousands of times more sensitive near a spectroscopic absorption band of the substance than at wavelengths removed from it. Such biological molecules as nucleic acids and aromatic amino acids maximally absorb in the 2600 Å and 2800 Å regions, respectively. Organic compounds formed by chemical synthesis generally consist of mixtures which rotate light in opposite directions and thus neutralize each other. It is a characteristic property of living things to select and synthesize forms which rotate polarized light in one direction.

---

## The Radioisotope Biochemical Probe: Gulliver

This instrument, named after Swift's famous fictional traveller to strange places, is designed to search for microbial life on Mars. The project scientists for NASA are Dr. Gilbert V. Levin of Hazleton Laboratories, Inc., and Dr. Norman H. Horowitz of the California Institute of Technology.

Gulliver consists of a culture chamber that inoculates itself with a sample of soil. The chamber contains a broth whose organic nutrients are labeled with radioactive carbon. When micro-organisms are put into the broth they metabolize the organic compounds, releasing radioactive carbon dioxide. The radioactive carbon dioxide is trapped on a chemically coated film at the window of a Geiger counter. The counter detects and measures the radioactivity; this information will be conveyed to a radio transmitter which will signal it to Earth. Gulliver can detect growth, as well as metabolism, by virtue of the fact that the rate of carbon dioxide production increases exponentially (geometrically) in growing cultures. Exponential production of carbon dioxide would provide strong evidence for life on Mars and would make it possible to estimate the generation time; that is, the time required for doubling the number of organisms in the culture.

In addition to a culture chamber and counter (actually a group of counters in anticoincidence circuitry), Gulliver contains a built-in sample collector. This mechanism consists of two 25-foot lengths of kite line and chenille wound on small projectiles. The windings are made in the manner of harpoon lines to prevent snagging, and the strings are coated with silicone grease to make them sticky. When the space package arrives on Mars, a miniaturized programmer will take charge of Gulliver (actually, at least two Gullivers will be used, one as a test instrument and the other as a control). The projectiles will be fired, deploying the lines over the surface of the planet. A tiny motor inside the chamber will then reel in the lines, together with adhering soil particles. After line retrieval, the chamber of Gulliver will be sealed, and an

ampule inside will be broken, releasing the previously sterilized radioactive medium onto the lines.

Both the test and control Gullivers will be inoculated with soil simultaneously, as described above, but the control instrument will be injected with a metabolic poison soon after inoculation. The purpose of this step is to make sure that any carbon dioxide evolution that is detected is of biological origin. If space is available for more than two Gullivers, the nature of the antimetabolite can be varied so as to provide information on the chemical sensitivity—and therefore on the chemical nature—of Martian life.

In principle, Gulliver is capable of performing many different kinds of metabolic and biochemical experiments. For example, a modified version of the current model would be able to detect photosynthesis by measuring the effects of light and darkness on the evolution of carbon dioxide. This application of Gulliver has been demonstrated in the laboratory. It is important

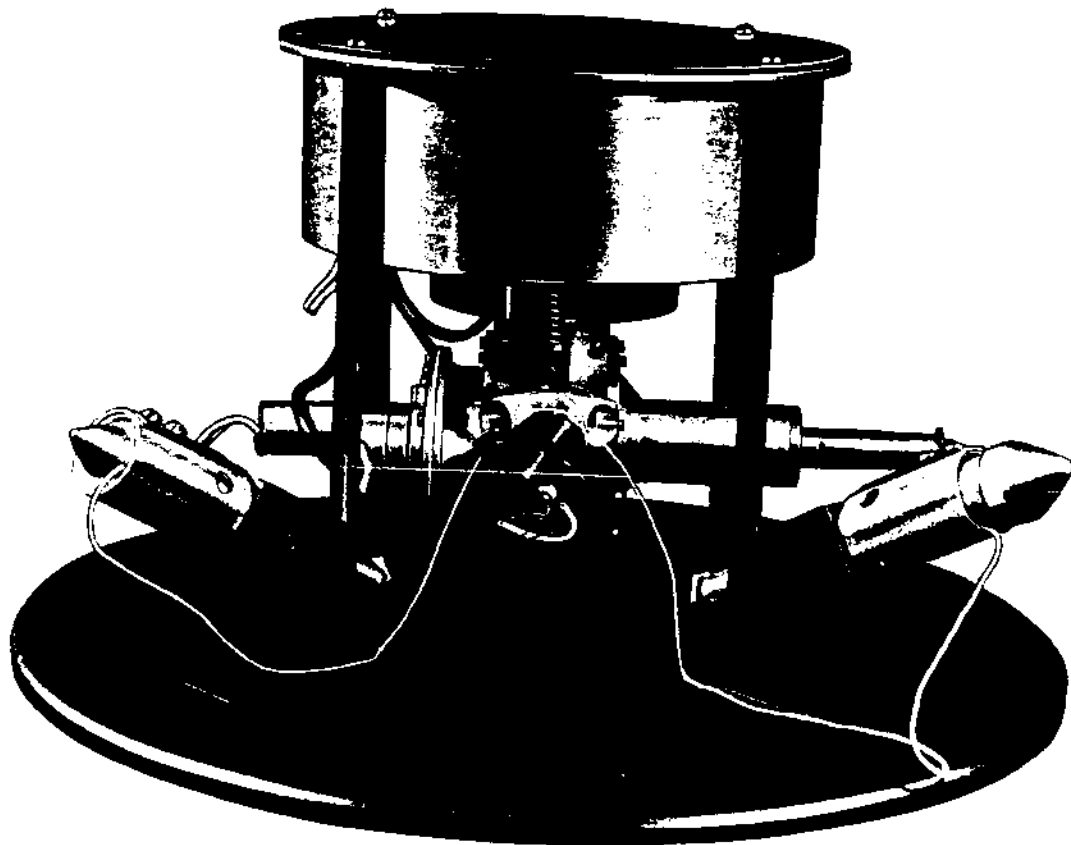

FIGURE 13.—A working model of Gulliver, tested under a variety of conditions.

because we can be certain that if life exists at all on Mars, there will be at least one photosynthetic species that captures energy from the Sun.

The composition of the medium is one of the most interesting problems connected with the Gulliver experiment. Obviously, the success of the experiment depends on the correct choice of nutrients. There are reasons for believing that if life exists on Mars it will be carbonaceous life, as it is on Earth. One can therefore feel reasonably confident that organic compounds of some kind will be metabolized by Martian organisms. However, as the number of possible organic compounds is virtually limitless, this premise does not narrow the range of choices very much. What we need for the Gulliver medium are organic substances that are readily decomposed into carbon dioxide by living organisms and that are of widespread occurrence in the solar system. This problem can be approached experimentally. In fact, the experiment has already been done and has been referred to in the introduction to this book; that is, the experiment of irradiating a mixture of gases simulating the primitive atmosphere of the Earth and planets. As Dr. Stanley Miller first showed, this experiment yielded a number of organic acids, such as formic, succinic, and lactic acids. These acids have exactly the characteristics referred to above: they are readily metabolized to carbon dioxide by terrestrial life, and there is reason to believe that they were formed in large amounts on primitive Mars. It is contemplated that these and a number of other compounds of a similar nature will be among the radioactive nutrients in the Gulliver medium.

Several working models of Gulliver have been built. The model shown in figure 13 has been tested under a variety of conditions: from the sand dunes of Death Valley to above tree-line at the 12,000-foot elevation on White Mountain, California, and from the salt desert of southern California to the woods of Rock Creek Park in Washington, D.C. In all of these places, Gulliver was able to detect microbial life in a matter of a few hours.

## The Wolf Trap

When Professor Wolf Vishniac conceived a device to search for life in space it was inevitable that his biologist friends would name it the "Wolf trap." The original Wolf trap was built to demonstrate on Earth the feasibility of detecting automatically the growth of micro-organisms on Mars. When operated either on the laboratory floor or outdoors, the feasibility model signals bacterial growth within a few hours after activation.

The heart of the Wolf trap is a growth chamber with an acidity (pH) detector and a light sensor; the former senses the changes in acidity which almost inevitably accompany the growth of micro-organisms, while the latter detects changes in the amount of light passing through the growth chamber. Micro-organisms, such as bacteria, turn a clear culture medium turbid (cloudy) when they grow. It is the change in turbidity which the light sensor measures. The pH measurement complements the turbidity measurement by providing an independent check on growth and metabolism. When either or both of these changes occur, the sensors can communicate this information to a telemetering device which in turn relays the results back to Earth.

The reason for first searching for micro-organisms on Mars is that even in the absence of higher plants and animals, the basic ecology (the interactions between the organisms in a biological community) would not be changed; it is possible to maintain a planetary ecology by micro-organisms alone, though not by animals and higher plants in the absence of micro-organisms.

The biological reasoning behind the particular approach of the Wolf trap was presented by Professor Vishniac as follows. All of the organisms of an environment must have a source of raw materials and energy for growth. Some, like the green plants, can use light energy to manufacture energy-rich chemicals (food); this process is named photosynthesis. Others, like humans, must consume either the photosynthetic plants, or animals which subsist

on the plants, for energy requirements. In photosynthesis plants *consume* carbon dioxide; animals eat the plants and *produce* carbon dioxide. Such an interdependent cycling of raw materials is common within a biological environment. A consideration of a known environment allows one to predict with reasonable accuracy the type of micro-organism that will flourish in it. Such predictions have nothing to do with the size and shape of the micro-organism, nor with its microscopic appearance or its molecular structure. They only deal with its physiology: activities, such as photosynthesis, which would enable an organism to flourish in such an environment.

These predictions are the basis for the several culture media now being considered for inclusion in a Mars-bound Wolf trap. The most important consideration in preparing these media is the knowledge that Mars lacks oxygen in its atmosphere. Hence, a number of media are being devised to support the life of probable anaerobic micro-organisms. A variety of media allows the biologist to test fundamental assumptions about the nature of life and its chemistry, and increases the likelihood of detecting at least one possible life form.

The detection principle of the Wolf trap is susceptible to a variety of modifications. The first device can be a simple unit to meet the weight and power requirements of early spacecraft, or it can be an elaborate multichambered experiment with varied media as mentioned above. The latter, of course, would have the greater scientific value.

The feasibility model has been completely redesigned, and a new model—the “breadboard” model—has been built incorporating changes to make it suitable for space flight (fig. 14). One improvement is a more sensitive method of detecting turbidity. The intensity of a beam of light passing through a turbid bacterial suspension will be reduced since some of the light is scattered to the sides. Instruments which can measure this reduction in direct light intensity “see” turbidity when 100 million organisms per milliliter are present. The unaided eye is a better detector since it can tell if a suspension is cloudy at a concentration of roughly 5 million organisms per milliliter. At least a thousand-fold greater sensitivity is possible by measuring the light scattered to the sides by the suspended organisms, rather than measuring the reduced intensity directly. The particular optical geometry which has been selected for the Wolf trap measures light scattered at an angle of approximately  $20^\circ$  off the forward beam. This system is shown in figure 15.

The response of the first model was a simple *yes-no* answer. It is more informative to continuously measure the change in turbidity as a result of microbial growth and telemeter to Earth the magnitude of the change. From

this is would be possible to plot a growth curve. Similarly, a change of acidity can be signaled by the pH detector in terms of rate change, rather than just a *yes-no* signal.

An essential feature of the Wolf trap operation is the sampling system. Originally a vacuum chamber was used to gather a sample of dust. When the Wolf trap was placed on the floor, a fragile glass shield was broken, allowing

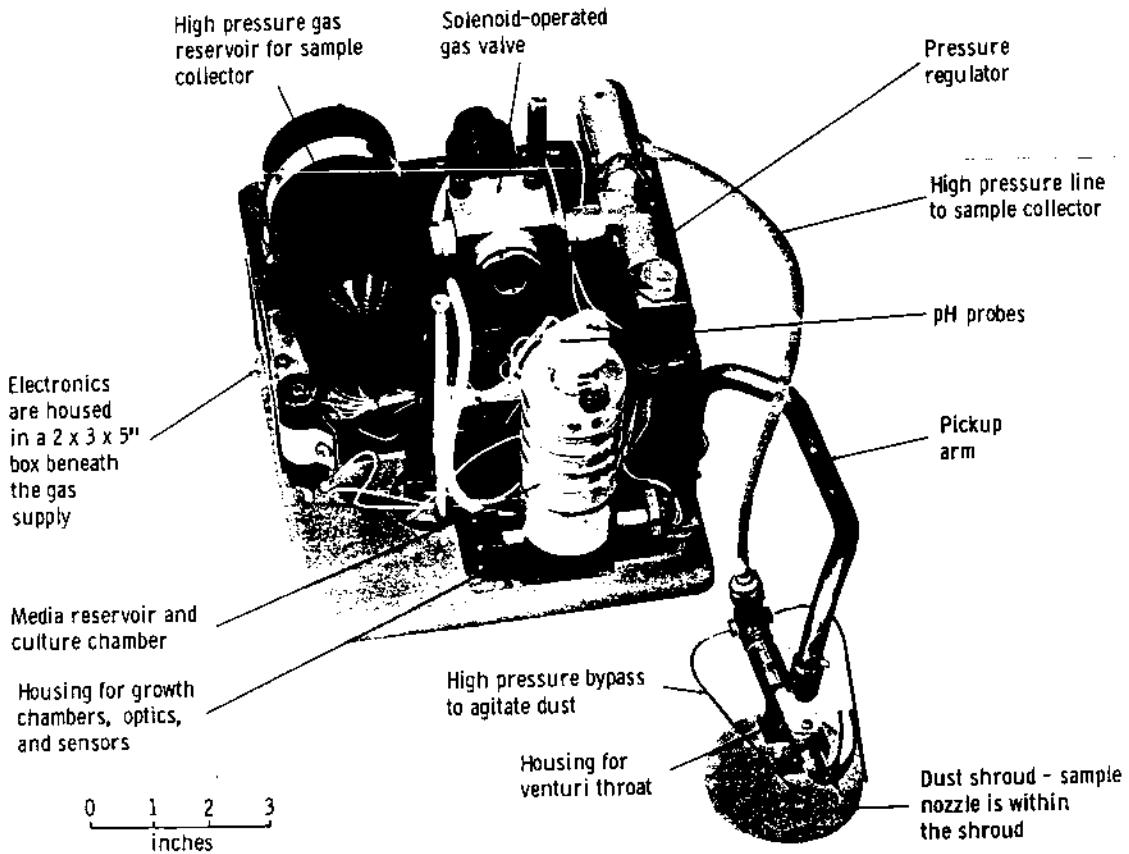

FIGURE 14.—Wolf trap experimental breadboard with cover removed. The Wolf trap measures 5 X 7 X 7 inches with the cover in place. The sample-collector is extended on the right. The black bottle on the left is the pickup-gas reservoir. Immediately to its right is a release valve and a pressure regulator which are connected to the pickup by the Teflon tubing. The electronics are packaged underneath the gas reservoir, gas valve, and pressure regulator and cannot be seen in this photograph. In front of the assembly, just to the right of center, are the media reservoir and media dump mechanisms. The culture chamber and sensor unit is partially obscured beneath the media reservoir.



the internal vacuum to suck dust into the culture chamber. The sampling mechanism of the breadboard model, like the early model, is based upon the sucking up of dust. However, instead of a "packaged" vacuum, compressed gas forced through a constricted throat produces a partial vacuum which sucks particles into the collection nozzle and carries them from there to the culture chamber.

When the soil inoculum is initially introduced into the culture chamber of the breadboard there is a relatively high signal which drops rapidly as the heavy sand-sized particles settle out of the suspension. The very small particles settle out of the suspension more slowly. Superimposed on this soil settling curve is the growth curve of the organisms. Starting from some low population level, the microbes begin to multiply. When the number of organisms is large enough (around 100,000 per milliliter in the present device) they begin to form a significant amount of the signal.

Naturally, the system cannot discriminate between soil and microorganisms. The Wolf trap could send a signal change even if there were nothing living on Mars, as, indeed, could any of the other life-detection devices. Suppose for instance, the Wolf trap lands on Mars and almost immediately signals a marked change in the culture medium; the signals show dense turbidity and the acidity increases greatly. About all such data would mean would be that the Martian surface is extremely dusty and the dust extremely acidic. However, if only a few of the chambers indicate change, and the changes are signaled over the course of several hours or a day, then it can be reasonably concluded that changes have taken place as a result of microbial activity, especially if the turbidity signal increases exponentially (doubled every hour or so), instead of climbing at a constant rate.

Sample acquisition poses one of the most difficult engineering problems in the Wolf trap, as in other life-detection devices. Light scattered by an abundance of small colloidal-sized soil particles might saturate the detectors, allowing the growth of organisms to go undetected. It would be equally unfortunate if an insufficient sample were collected. The concern over the sampling problem is reflected in figure 14, where fully half the volume of the experimental breadboard is taken up by sampling system components. Although it is more complex, the Wolf trap breadboard is less than one-third the size and one-sixth the weight of the original feasibility model. Yet the device is still not as compact as possible. The design engineers of the Wolf trap point out that the bulky solenoid-operated valves in the breadboard can be replaced by one-shot rupture diaphragms in the flight model. This would represent a considerable saving in weight and space.

The next step is greater refinement of the entire system to reduce its size, increase its detector sensitivity, improve the sample collection efficiency, and fully qualify the instrument for space flight so that the Wolf trap will be ready for installation in a Mars-bound spacecraft.

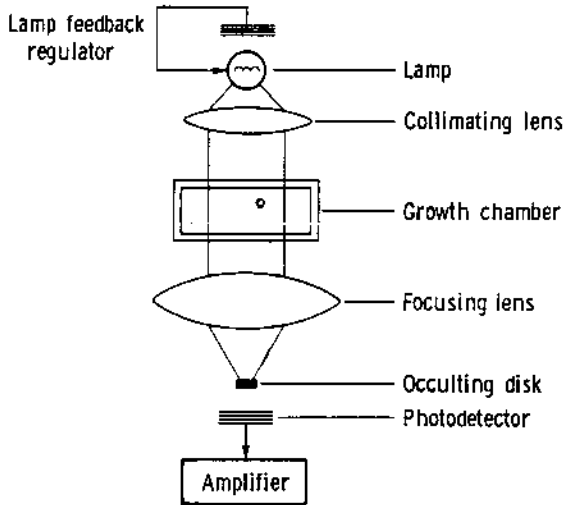

FIGURE 15.—Wolf trap optics.

## The Multivator Life-Detection System

The multivator is a miniature laboratory for conducting a variety of biochemical or biological experiments on Mars. The nature of the experiments is limited only by those biological properties which can be measured by a photomultiplier as an output transducer. The device was conceived by Dr. Joshua Lederberg at Stanford University. The experiment which has received Dr. Lederberg's particular attention is the detection of phosphatase activity. This is because:

1. phosphatase is widespread among terrestrial organisms;
2. it catalyzes the hydrolysis of phosphate esters with moderate specificity;
3. it is involved with the role of phosphorus in metabolism and energy transfer which may be a universal characteristic of carbon-based aqueous living systems; and
4. it is capable of being detected with relatively high sensitivity.

A functional test for the presence of hydrolytic enzymes, such as phosphatase, detects the catalysis of  $AB + H_2O \xrightarrow{\text{enzyme}} AH + BOH$ . The basis of the phosphatase test is the release of AH which differs from AB in being fluorescent. In this case, A is a fluorescent residue and B is a phosphate that permits the fluorometric assay of phosphatase. The multivator is designed to carry out such assays as well as many others. It does this by mimicking in miniature a great many of the kinds of instruments used in a typical biochemical laboratory. The basic elements of the instruments are a light source followed by a filter; the sample under investigation; another filter centered at either the same wavelength as the excitation filter for colorimetry or light scattering, or at a different wavelength if fluorometric observations are to be made; and finally, a light detector, usually a photomultiplier. Figure 16 shows several cut-away views of the multivator.

The most recent version of the multivator consists of 15 modules arranged in a circle around an impeller (figs. 17 and 18). Each of the modules basically

consists of a reaction chamber, solvent storage chamber, tapered valve pin, explosive-charge bellows motor, and a filtered light source. The entire solvent chamber is sealed prior to operation by a thin diaphragm which is placed in front of the pointed valve tip.

In operation, dust-bearing air is drawn through the impeller and in front of the reaction chambers. The impeller imparts sufficient velocity to particles above  $10\mu$  in diameter to fling them into the reaction chambers where they tend to settle. Upon completion of the particle-collecting operation, the explosive-charged bellows motors are electrically ignited. Expansion of the bellows results in the sealing of the reaction chambers and the injection of the solvent. The substrate materials, which have been stored dry in the reaction chambers during flight, are dissolved and the reaction begins. After a preset re-

#### MULTIVATOR CHAMBERS

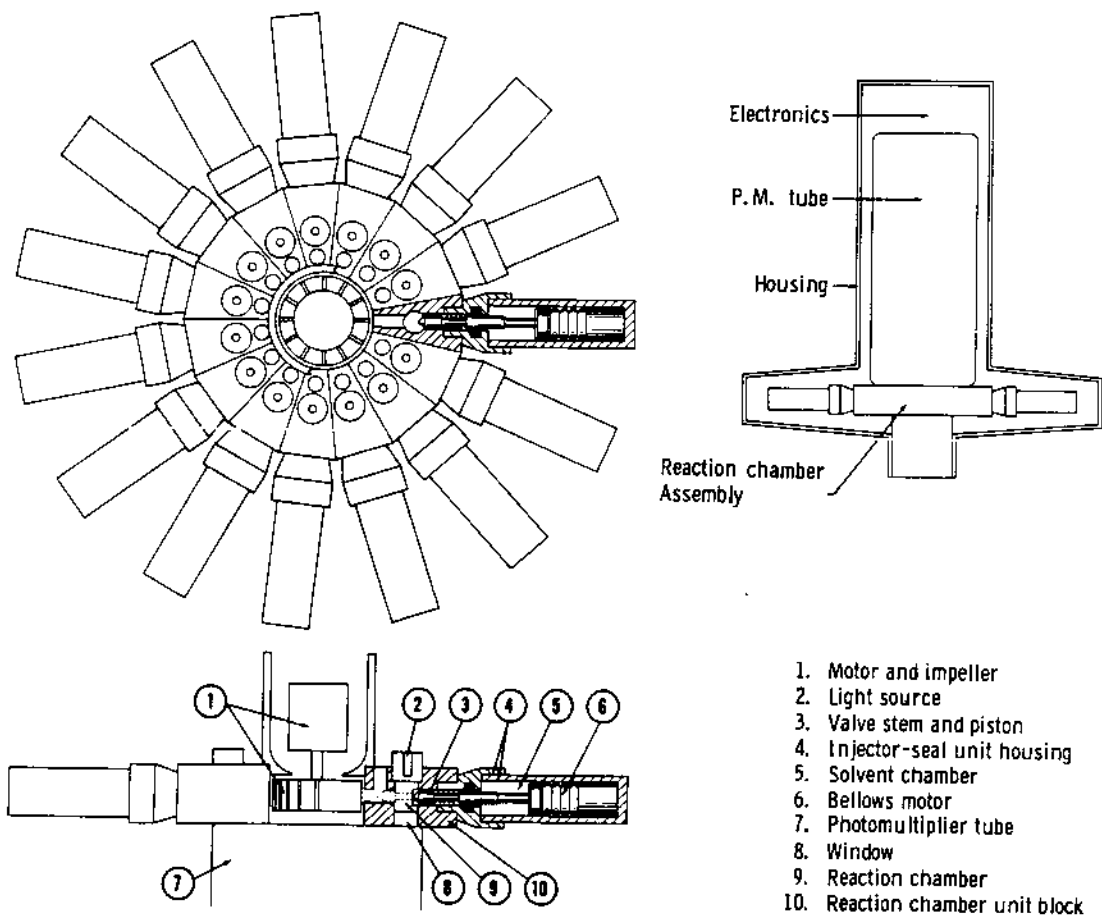

FIGURE 16.—Layout of the multivator assembly.

action time, the excitation lamps are turned on sequentially and the light signal, or fluorescent level in the case of the phosphatase assay, is detected by the photomultiplier tube. This information is then reduced to digital form and transmitted. One reading per chamber every 15 minutes would be satisfactory, requiring a fraction of a bit per second for telemetry. Certain chambers of the instrument are designed so that they will not collect soil. This permits a comparison of the behavior of the solvent-substrate mixtures subjected to the same conditions of voyage and Martian environment with the results from those reaction chambers receiving dust samples. This helps to ensure that the information concerning a sign of life is not due to a faulty test.

Modular design of the multivator offers several advantages. First, the entire multivator becomes potentially more reliable with 15 independently operated modules. Secondly, each module may be filled with different types of solvents, thereby increasing the range of experiments that can be performed with a single multivator package. Thirdly, the modular design allows more flexibility in making the final choice of the actual experiment to be performed. It also permits postponing this choice to a relatively short time before the launch date of the mission. More than a full complement of modules could be under design and development; postponement of final choice would not interfere with orderly spacecraft development and construction as long as the experiments met the very simple interface parameters characteristic of the multivator experimental modules.

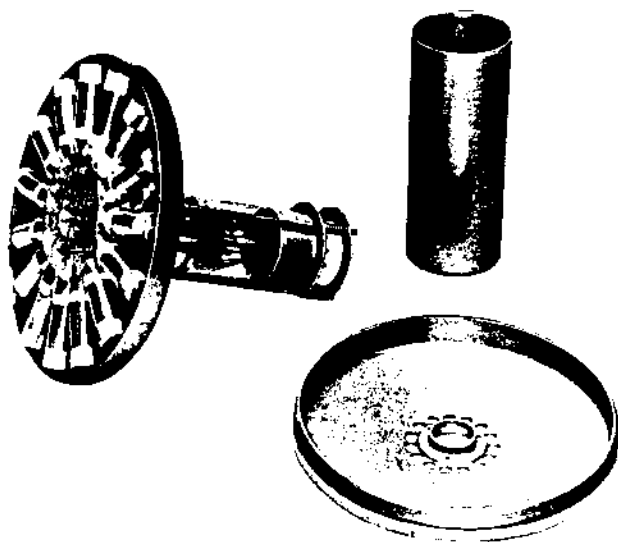

FIGURE 17.—Multivator, with housing partially removed.

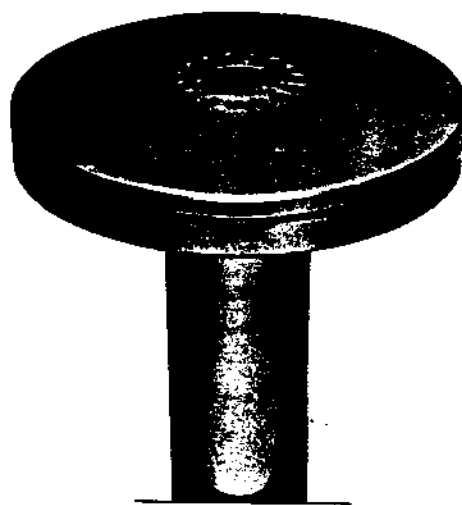

FIGURE 18.—Assembled multivator.

## The Mars Mariners and Voyagers

The first spacecraft destined for Mars will be Mariner C, a NASA planetary flyby scheduled for launching in 1964.

Mars and Earth both orbit the Sun in the same direction, but not at the same speed or distance. The mean distance of Earth from the Sun is 93 million miles, while the mean distance of Mars from the Sun is 141 million miles. Earth makes one revolution around the Sun each  $365\frac{1}{4}$  days, while Mars revolves around the Sun once every 687 earth days.

The maximum distance between Earth and Mars is about 247 million miles, which occurs at the aphelion conjunction. However, when Mars is at opposition, the two planets (Earth and Mars) can be as close together as 34.5 million miles or as far away from each other as 63 million miles. Oppositions are usually considered in planning missions to Mars. It is emphasized that neither spacecraft launch nor encounter would occur exactly at these opposition distances because the planets are in orbital motion at different velocities, as was already mentioned. From a search-for-life point of view, it is important to launch so that arrival coincides with those times when the wave of darkening on Mars is most pronounced.

Mariner C is not intended to land on Mars, but to fly past it at a distance of about 15,000 km. It will carry instrumentation to obtain data on interplanetary dust and plasma and to take television photographs of Mars. In addition, experiments are to be aboard to obtain data on the magnetic field and cosmic rays. The final dimensions of Mariner C will be similar to Mariner II which flew past Venus on December 14, 1962.

The hexagonal framework of Mariner II housed a liquid-fuel rocket motor for trajectory correction. It had six modules or compartments containing the attitude control system, electronic circuitry for the scientific experiments, power supply, battery and charger, data encoder, and command subsystem for receiving and obeying signals from Earth, digital computer and sequencer, and radio transmitter and receiver.

The solar panels, with 9,800 solar cells, collected energy from the Sun and converted it into electrical power. Two-way communications were supplied by the receiver/transmitter, two transmitting antennas and the command antenna for receiving. Stabilization for yaw, pitch, and roll was provided by 10 cold-gas jets mounted in four locations and fed by two titanium bottles.

A later Mariner will carry additional devices past Mars in 1966-67. If an instrumented package does land on the Martian surface it will be to determine the density profile of the Martian atmosphere. Not until 1969, 1971, or 1973 will actual life-detection devices, using systems evolved from Mariner-level payloads to larger payloads of the Voyager class, be considered for effective surface landing and operation.

One of the flyby experiments may consist of an infrared scanning system capable of measuring reflected visible radiation, emitted surface radiation (thermal), and radiation absorbed by atmospheric water vapor. Figure 19 shows the general optical scheme for the instrument. This type of Mars "mapping" will provide useful information with respect to microenvironments for possible extraterrestrial life.

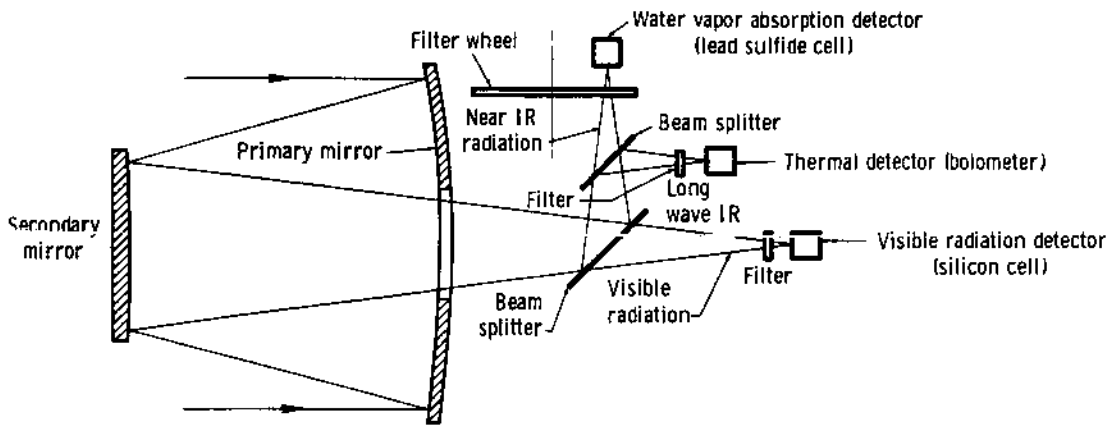

FIGURE 19.—Optical schematic diagram for Mars scanner.

# Bibliography

## Chapter I

- deVaucouleurs, G.: *Physics of the Planet Mars*. Faber and Faber (London), 1954.
- Sagan, C.: On the Origin and Planetary Distribution of Life. *Rad. Res.*, 15: 174, 1961.
- Sagan, C.: Exobiology: A Critical Review. *Life Sciences and Space Research II*, M. Florin, ed., North Holland Publishing Company (Amsterdam), 1964.
- Sagan, C. and Kellogg, W. W.: The Terrestrial Planets. *Ann. Rev. Astronomy and Astrophysics*, 1: 235, 1963.
- Urey, H. C.: *The Planets*. Yale University Press, 1952.
- Whipple, F. L.: *Earth, Moon and Planets*. Revised edition, Harvard University Press, 1963.

## Chapter III

- Lederberg, J.: Exobiology: Experimental Approaches to Life Beyond Earth. *Science in Space*, L. V. Berkner and H. Odishaw, eds., McGraw-Hill, 1961, pp. 418-421.

## Chapter IV

- Knox, J. H.: *Gas Chromatography*. John Wiley and Sons, 1962.
- Landoune, R. A. and Lipsky, S. R.: High Sensitivity Detection of Amino Acids by Gas Chromatography and Electron Affinity Spectrometry. *Nature*, 199: 141, 1963.
- Oyama, V. J.: Uses of Gas Chromatography for the Detection of Life on Mars. *Nature*, 200: 1058, 1963.

## Chapter V

- Benyon, J. H.: *Mass Spectrometry and Its Application to Organic Chemistry*. D. Van Nostrand and Company, 1960.
- Biemann, K., Seible, J. and Gapp, F.: Mass Spectrometric Identification of Amino Acids. *Biochem. Biophys. Res. Commun.*, 1: 307, 1959.
- Biemann, K. and Vetter, W.: Quantitative Amino Acid Analysis by Mass Spectrometry. *Biochem. Biophys. Res. Commun.*, 2: 30, 1960.



## Chapter VI

Nelson, S.: Absorption in the Far Ultraviolet by the Peptide Bond. *Abstracts of the Eighth Annual Meeting of the Biophysics Society*, 1964.

## Chapter VII

Kay, R. E., Walwick, E. W. and Gifford, C. K.: Spectral Changes in Cationic Dye Due to Interaction with Macromolecules. Part 1. Behavior of Dialysate in Solution and the Effect of Added Macromolecules. Part 2. Effects of Environment and Macromolecular Structure. *J. Phys. Chem.*, 68: 1896-1906, 1907-1916.

## Chapter VIII

Carroll, B. and Blei, I.: Measurement of Optical Activity: New Approaches. *Science*, 142: 200, 1963.

Djerassi, C.: *Optical Rotatory Dispersion*. McGraw-Hill, 1960.

## Chapter IX

Levin, G. V., Heim, A. H., Thompson, M. F., Horowitz, N. H. and Beem, D. R.: Gulliver, An Instrument for Extraterrestrial Life Detection. *Life Sciences and Space Research II*, M. Florkin, ed., North Holland Publishing Company (Amsterdam), 1964.

Levin, G. V., Heim, A. H., Clendenning, J. R. and Thompson, M. F.: Gulliver—A Quest for Life on Mars. *Science*, 138: 114, 1962.

## Chapter X

Vishniac, W.: The Wolf Trap. *Life Sciences and Space Research II*, M. Florkin, ed., North Holland Publishing Company (Amsterdam), 1964.

## Chapter XI

Levinthal, E.: Multivator—A Biochemical Laboratory for Martian Experiments. *Life Sciences and Space Research II*, M. Florkin, ed., North Holland Publishing Company (Amsterdam), 1964.

## Suggested Reading: Background and Introductory Information

- Calvin, M.: Communications: From Molecules to Mars. *AIBS Bulletin*, 12: 29, 1962.
- Darwin, C.: *On the Origin of Species* (a facsimile of the first-edition). Harvard University Press, 1963. Many other editions exist.
- Horowitz, N. H.: Biology in Space. *Fed. Proc.*, 21: 687, 1962.
- Horowitz, N. H.: The Design of Martian Biological Experiments. *Life Sciences and Space Research II*, M. Florkin, ed., North Holland Publishing Company (Amsterdam), 1964.
- Horowitz, N. H. and Miller, S. L.: Current Theories on the Origin of Life. *Fortschritte der Chemie organischer Naturstoffe*, 20: 423, 1962.
- Lederberg, J.: *Exobiology Approaches to Life Beyond Earth*. *Science*, 132: 393, 1960.
- Lwoff, A.: *Biological Order*. MIT Press, 1962.
- Mamikunian, G. and Briggs, M. H., eds.: *Current Aspects of Exobiology*. Pergamon Press, 1965.
- Merrill, P. W.: *Space Chemistry*. University of Michigan Press, 1963.
- Miller, S.: The Mechanism of Synthesis of Amino Acids by Electric Discharges. *Biochimica and Biophysica Acta*, 23: 480, 1957.
- National Academy of Science—National Research Council: *A Review of Space Research*. Publication 1079, Chapter IX, 1962.
- Quimby, F. H.: Some Criteria of Living Systems Useful in the Search for Extraterrestrial Life. *Developments in Industrial Microbiol*, 5: 224, 1964.
- Thomas, S.: *Men of Space—Profiles of Scientists Who Probe for Life in Space*. Vol. 6, Chilton Publishing Company, 1963.
- Vishniac, W.: Terrestrial Models for Extraterrestrial Organisms. *Life Sciences and Space Research II*, M. Florkin, ed., North Holland Publishing Company (Amsterdam), 1964.
- Weisz, P. B.: *The Science of Biology*. McGraw-Hill, 1949.
- Young, R. S. and Ponnampetuma, C.; Early Evolution of Life. *Biological Sciences Curriculum Study No. 11*, W. Auffenberg, ed., D.C. Heath and Company, Boston, 1964.

*"The aeronautical and space activities of the United States shall be conducted so as to contribute . . . to the expansion of human knowledge of phenomena in the atmosphere and space. The Administration shall provide for the widest practicable and appropriate dissemination of information concerning its activities and the results thereof."*

—NATIONAL AERONAUTICS AND SPACE ACT OF 1958

## NASA SCIENTIFIC AND TECHNICAL PUBLICATIONS

**TECHNICAL REPORTS:** Scientific and technical information considered important, complete, and a lasting contribution to existing knowledge.

**TECHNICAL NOTES:** Information less broad in scope but nevertheless of importance as a contribution to existing knowledge.

**TECHNICAL MEMORANDUMS:** Information receiving limited distribution because of preliminary data, security classification, or other reasons.

**CONTRACTOR REPORTS:** Technical information generated in connection with a NASA contract or grant and released under NASA auspices.

**TECHNICAL TRANSLATIONS:** Information published in a foreign language considered to merit NASA distribution in English.

**TECHNICAL REPRINTS:** Information derived from NASA activities and initially published in the form of journal articles.

**SPECIAL PUBLICATIONS:** Information derived from or of value to NASA activities but not necessarily reporting the results of individual NASA-programmed scientific efforts. Publications include conference proceedings, monographs, data compilations, handbooks, sourcebooks, and special bibliographies.

*Details on the availability of these publications may be obtained from:*

SCIENTIFIC AND TECHNICAL INFORMATION DIVISION  
NATIONAL AERONAUTICS AND SPACE ADMINISTRATION  
Washington, D.C. 20546

**ORDER FORM**

Majic Eyes Only: Earth's Encounters with ET Technology (320pgs-hardback) (\$30)....	QTY _____	\$ _____
DVD of "The Secret" as Seen on Sci-Fi Channel (\$18).....	QTY _____	\$ _____
Majestic Documents Book (190 pages) (\$18).....	QTY _____	\$ _____
CD "The Secret" Authenticity of MJ Documents (\$5).....	QTY _____	\$ _____
SOM1-01-ET Technology Recovery and Disposal (\$5).....	QTY _____	\$ _____
1st Annual Conference Proceedings (227pages) (\$35).....	QTY _____	\$ _____
CD Audio Set of 1st UFO Crash Retrieval Conf (\$160).....	QTY _____	\$ _____
2nd Annual Conference Proceedings (251 pages) (\$35).....	QTY _____	\$ _____
DVD Set of 2nd UFO Crash Retrieval Conf (\$240).....	QTY _____	\$ _____

**Individual DVD's of 2nd Crash Con Speakers (\$20)**

Nick Redfern – Crashed UFOs – Worldwide History.....	QTY _____	\$ _____
Jim Marrs – The Very First UFO Crash Retrieval 1896?.....	QTY _____	\$ _____
Don Ledger – Shag Harbor Incident.....	QTY _____	\$ _____
Peter Robbins – Brentwaters/ Woodbridge.....	QTY _____	\$ _____
Linda Moulton Howe – US Policy of Denial In the Interest of National Security.....	QTY _____	\$ _____
Grant Cameron – The Presidents Hard Evidence (both parts).....	QTY _____	\$ _____
Stephen Bassett – A Message to President Elect – Truth Retrieval.....	QTY _____	\$ _____
Dr. Robert Wood – Correlating Leonard Stringfield's Crash Reports.....	QTY _____	\$ _____
Paul Davids – The Road to Roswell – Undisputed Facts and Factual Disputes.....	QTY _____	\$ _____
Dr. David Pace – Inside the USSR Majestic 12 Program.....	QTY _____	\$ _____
Ryan Wood – Murder and Majestic 12 – Investigation of UFO Related Deaths.....	QTY _____	\$ _____
<b>Various Presenters: three 30 minute contributed talks:</b> Paul Kimball: Crash at Aztec;		
Chuck Wade: Debris from Plains UFO crash; Ron Regehr: Ramey Office photographs.....	QTY _____	\$ _____

3rd Annual Conference Proceedings (200 pages) (\$35).....	QTY _____	\$ _____
DVD Set of 3rd UFO Crash Retrieval Conf (\$240/set).....	QTY _____	\$ _____

**Individual DVD's of 3rd Crash Con Speakers (\$20/each)**

Dr. Robert Wood- Examination of Reverse Engineering Claims.....	QTY _____	\$ _____
Dr. Tom Valone – UFO Energy & Antigravity Systems.....	QTY _____	\$ _____
Speaker Panel Moderated by Stephen Bassett.....	QTY _____	\$ _____
Dr. Roger Leir – The Varginha Brazil UFO crash.....	QTY _____	\$ _____
Linda Moulton Howe –1953, DRES, Millard County, UT Crash.....	QTY _____	\$ _____
Nick Redfern – Big Thicket, TX Crash & 1953 Kingman AZ crash.....	QTY _____	\$ _____
Richard Dolan – Sociological & Political Implications of Disclosure.....	QTY _____	\$ _____
Chuck Zukowski, Debbie Ziegelmeyer – Roswell Archeological Dig Results.....	QTY _____	\$ _____
Reme Baca – San Antonio, NM 1945 UFO Crash.....	QTY _____	\$ _____
Jim Marrs – Keynote – Will Rocket Engines Go The Way Of The Dodos?.....	QTY _____	\$ _____
Ryan Wood –New Book – Majic Eyes Only.....	QTY _____	\$ _____
Peter Robbins – Orgone Energy & Wilhelm Reich & UFOs.....	QTY _____	\$ _____
Dr. Roger Leir – Analysis of Metal Fragments from UFO.....	QTY _____	\$ _____
Bill Hamilton – The Case for Reverse Engineering.....	QTY _____	\$ _____
Ken Storch – Arizona 1998 Landed UFO, Military & Murder.....	QTY _____	\$ _____

**Individual DVD's of 4th Crash Con Speakers (\$20/each)**

Stanton Friedman - The UFO "Why" Questions.....	QTY _____	\$ _____
Dr. Michael Salla – The Covert World of UFO Crash Retrievals.....	QTY _____	\$ _____
Richard Dolan – UFO Crash Retrievals: Leaks and Secrecy.....	QTY _____	\$ _____
Paul Schatzkin – Defying Gravity: Material on T. Townsend Brown.....	QTY _____	\$ _____
Ryan Wood – The Devils Hole UFO Crash Retrieval.....	QTY _____	\$ _____
Peter Merlin – How the Government Responds to Top Secret Crashes.....	QTY _____	\$ _____
Michael Lindemann – Scenarios of Contact.....	QTY _____	\$ _____
George Knapp – TV Journalist' Perspective on Ufology.....	QTY _____	\$ _____
Robert M. Wood, Ph.D. – Alien Viruses and Leaked Documents.....	QTY _____	\$ _____
Nick Redfern – Crashed UFO's and Bio-Warfare.....	QTY _____	\$ _____
Frank Feshino – The Braxton County Monster.....	QTY _____	\$ _____
Linda Moulton Howe – Military Voices: Firsthand Testimonies.....	QTY _____	\$ _____
Dr. Bruce Maccabee – December 6, 1950 UFO Crash Retrieval.....	QTY _____	\$ _____
Matthew E. Thuney – The Lummi Island Incident.....	QTY _____	\$ _____

1st Annual UFO Crash Retrieval Conference Audio Tape Set (2003) (\$160)....	QTY _____	\$ _____
Shipping and Handling (\$8.00).....		\$ _____

Total Paid.....||

Please Print and Send Check, Money Order or Credit Card Info

Name: \_\_\_\_\_  
 Address: \_\_\_\_\_ City: \_\_\_\_\_ State: \_\_\_\_\_ Zip: \_\_\_\_\_  
 Phone: Work \_\_\_\_\_ Home \_\_\_\_\_  
 Fax: \_\_\_\_\_ Email: \_\_\_\_\_

(Circle) Visa/MasterCard Number: \_\_\_\_\_ - \_\_\_\_\_ - \_\_\_\_\_ Expires: \_\_\_\_\_ / \_\_\_\_\_  
 Security Code on back of card \_\_\_\_\_

Signature: \_\_\_\_\_